

# **marantz®**

**Model SR6001 User Guide**

---

AV Surround Receiver

## ENGLISH

### **WARRANTY**

For warranty information, contact your local Marantz distributor.

### **RETAIN YOUR PURCHASE RECEIPT**

Your purchase receipt is your permanent record of a valuable purchase. It should be kept in a safe place to be referred to as necessary for insurance purposes or when corresponding with Marantz.

### **IMPORTANT**

When seeking warranty service, it is the responsibility of the consumer to establish proof and date of purchase. Your purchase receipt or invoice is adequate for such proof.

### **FOR U.K. ONLY**

This undertaking is in addition to a consumer's statutory rights and does not affect those rights in any way.

## FRANÇAIS

### **GARANTIE**

Pour des informations sur la garantie, contacter le distributeur local Marantz.

### **CONSERVER L'ATTESTATION D'ACHAT**

L'attestation d'achat est la preuve permanente d'un achat de valeur. La conserver en lieu sûr pour s'y reporter aux fins d'obtention d'une couverture d'assurance ou dans le cadre de correspondances avec Marantz.

### **IMPORTANT**

Pour l'obtention d'un service couvert par la garantie, il incombe au client d'établir la preuve de l'achat et d'en corroborer la date. Le reçu ou la facture constituant des preuves suffisantes.

## DEUTSCH

### **GARANTIE**

Bei Garantiefragen wenden Sie sich bitte an Ihren Marantz-Händler.

### **HEBEN SIE IHRE QUITTING GUT AUF**

Die Quittung dient Ihnen als bleibende Unterlage für Ihren wertvollen Einkauf. Das Aufbewahren der Quittung ist wichtig, da die darin enthaltenen Angaben für Versicherungszwecke oder bei Korrespondenz mit Marantz angeführt werden müssen.

### **WICHTIG!**

Bei Garantiefragen muß der Kunde eine Kaufunterlage mit Kaufdatum vorlegen. Ihren Quittung oder Rechnung ist als Unterlage ausreichend.

## NEDERLANDS

### **GARANTIE**

Voor inlichtingen omtrent garantie dient u zich tot uw plaatselijke Marantz.

### **UW KWITANTIE, KASSABON E.D. BEWAREN**

Uw kwitantie, kassabon e.d. vormen uw bewijs van aankoop van een waardevol artikel en dienen op een veilige plaats bewaard te worden voor evt. verwijzing bij, in verbind met verzekering of bij correspondentie met Marantz.

### **BELANGRIJK**

Bij een evt. beroep op de garantie is het de verantwoordelijkheid van de consument een gedateerd bewijs van aankoop te tonen. Uw kassabon of factuur zijn voldoende bewijs.

## ESPAÑOL

### **GARANTIA**

Para obtener información acerca de la garantía póngase en contacto con su distribuidor Marantz.

### **GUARDE SU RECIBO DE COMPRA**

Su recibo de compra es su prueba permanente de haber adquirido un aparato de valor. Este recibo deberá guardarlo en un lugar seguro y utilizarlo como referencia cuando tenga que hacer uso del seguro o se ponga en contacto con Marantz.

### **IMPORTANTE**

Cuando solicite el servicio otorgado por la garantía el usuario tiene la responsabilidad de demostrar cuándo efectuó la compra. En este caso, su recibo de compra será la prueba apropiada.

## ITALIANO

### **GARANZIA**

L'apparecchio è coperto da una garanzia di buon funzionamento della durata di un anno, o del periodo previsto dalla legge, a partire dalla data di acquisto comprovata da un documento attestante il nominativo del Rivenditore e la data di vendita. La garanzia sarà prestata con la sostituzione o la riparazione gratuita delle parti difettose.

Non sono coperti da garanzia difetti derivanti da uso improprio, errata installazione, manutenzione effettuata da personale non autorizzato o, comunque, da circostanze che non possano riferirsi a difetti di funzionamento dell'apparecchio. Sono inoltre esclusi dalla garanzia gli interventi inerenti l'installazione e l'allacciamento agli impianti di alimentazione.

Gli apparecchi verranno riparati presso i nostri Centri di Assistenza Autorizzati. Le spese ed i rischi di trasporto sono a carico del cliente.

La casa costruttrice declina ogni responsabilità per danni diretti o indiretti provocati dalla inosservanza delle prescrizioni di installazione, uso e manutenzione dettagliate nel presente manuale o per guasti dovuti ad uso continuato a fini professionali.

## SVENSKA

### **GARANTI**

För information om garantin, kontakta Marantz lokalagent.

### **SPAR KVITTOT**

Kvittot är ett inköpsbevis på en värdefull vara. Det skall förvaras säkert och hänvisas till vid försäkringsfall eller vid korrespondens med Marantz.

### **VIKTIGT**

Fö att garantin skall gälla är det kundens sak att framställa bevis och datum om köpet. Kvitto eller faktura är tillräckligt bevis för detta.

# CE MARKING



## English

The SR6001 is in conformity with the EMC directive and low-voltage directive.



## Français

Le SR6001 est conforme à la directive EMC et à la directive sur les basses tensions.



## Deutsch

Das Modell SR6001 entspricht den EMC-Richtlinien und den Richtlinien für Niederspannungsgeräte.



## Nederlands

De SR6001 voldoet aan de EMC eisen en de vereisten voor laag-voltage.



## Español

El SR6001 está de acuerdo con las normas EMC y las relacionadas con baja tensión.



## Italiano

Il SR6001 è conforme alle direttive CEE ed a quelle per i bassi voltaggi.



## Svenska

SR6001 är tillverkad i enlighet med EMC direktiven och direktiven för lågvoltstrusning.

## English

### WARNINGS

- Do not expose the equipment to rain or moisture.
- Do not remove the cover from the equipment.
- Do not insert anything into the equipment through the ventilation holes.
- Do not handle the mains cord with wet hands.
- Do not cover the ventilation with any items such as tablecloths, newspapers, curtains, etc.
- No naked flame sources, such as lighted candles, should be placed on the equipment.
- When disposing of used batteries, please comply with governmental regulations or environmental public instruction's rules that apply in your country or area.
- Make a space of about 0.2 meter around the unit.
- No objects filled with liquids, such as vases, shall be placed on the equipment.
- When the switch is in the OFF position, the equipment is not completely switched off from MAINS.
- The equipment shall be installed near the power supply so that the power supply is easily accessible.
- Do Not Touch Hot Spots During and Immediately After Use.
- During and immediately after use, this product is hot in areas other than the controls and rear panel connection jacks. Do not touch hot spots and especially the top panel. Contact with hot areas can cause burns.

## Français

### AVERTISSEMENTS

- Ne pas exposer l'appareil à la pluie ni à l'humidité.
- Ne pas essayer de retirer le boîtier de l'appareil.
- Ne rien insérer dans l'appareil par les orifices de ventilation.
- Ne pas manipuler le cordon d'alimentation avec les mains mouillées.
- Ne pas recouvrir les ouïes de ventilation avec un objet quelconque comme une nappe, un journal, un rideau, etc.
- Ne placer aucune source de flamme nue, comme une bougie allumée, sur l'appareil.
- Pour mettre au rebut les piles usées, respecter les lois gouvernementales ou les règlements officiels concernant l'environnement qui s'appliquent à votre pays ou région.
- Veiller à ce qu'aucun objet ne soit à moins de 0,2 mètre des côtés de l'appareil.

- Aucun objet rempli de liquide, un vase par exemple, ne doit être placé sur l'appareil.
- Lorsque l'interrupteur est sur la position OFF, l'appareil n'est pas complètement déconnecté du SECTEUR (MAINS).
- L'appareil sera installé près de la source d'alimentation, de sorte que cette dernière soit facilement accessible.
- Ne pas toucher aux zones chaudes pendant et immédiatement après l'utilisation.
- Pendant l'utilisation et immédiatement après, cet appareil est chaud en dehors des commandes et des prises de raccordement arrière. Ne pas toucher aux zones chaudes, et particulièrement au panneau supérieur, pour éviter tout risque de brûlure.

## Deutsch

### WARNHINWEISE

- Das Gerät nicht Regen oder Feuchtigkeit aussetzen.
- Die Abdeckung nicht vom Gerät abnehmen.
- Keine Gegenstände durch die Belüftungsschlitze stecken.
- Das Netzkabel nicht mit feuchten oder nassen Händen anfassen.
- Decken Sie die Lüftungsöffnungen nicht mit einem Tischtuch, einer Zeitung, einem Vorhang usw. ab.
- Es dürfen keine Gegenstände mit offener Flamme, wie etwa brennende Kerzen, auf dem Gerät aufgestellt werden.
- Beachten Sie bei der Entsorgung der verbrauchten Batterien alle geltenden lokalen und überregionalen Regelungen.
- Auf allen Geräteseiten muß ein Zwischenraum von ungefähr 0,2 meter vorhanden sein.
- Auf das Gerät dürfen keine mit Flüssigkeiten gefüllte Behälter, wie etwa eine Vase, gestellt werden.
- Wenn der Schalter ausgeschaltet ist (OFF-Position), ist das Gerät nicht vollständig vom Stromnetz (MAINS) abgetrennt.
- Das Gerät sollte in der Nähe einer Netzsteckdose aufgestellt werden, damit es leicht an das Stromnetz angeschlossen werden kann.
- Berühren Sie während oder unmittelbar nach dem Gebrauch keine heißen Stellen des Gerätes.
- Während oder unmittelbar nach dem Gebrauch ist dieses Produkt mit Ausnahme der Bedienelemente und der Anschlussbuchsen auf der Rückseite heiß. Berühren Sie die heißen Stellen und insbesondere die Oberseite nicht. Der Kontakt mit heißen Flächen kann zu Verbrennungen führen.

## **Nederlands**

### **WAARSCHUWINGEN**

- Stel het apparaat niet bloot aan regen of vocht.
- Verwijder de afdekplaat van het apparaat niet.
- Duw niets door de ventilatieopeningen in het apparaat.
- Raak het netsnoer niet met natte handen aan.
- Bedek de ventilatieopeningen niet met enige voorwerpen, zoals tafelkleden, kranten, gordijnen, enz.
- Plaats geen brandende voorwerpen, zoals kaarsen, op het apparaat.
- Volg bij het weggoien van verbruikte batterijen de overheidswetgeving of milieuvoorschriften op die van kracht zijn in het land of de regio waarin u zich bevindt.
- Zorg dat er 0,2 meter vrije ruimte rond het toestel is.
- Plaats geen voorwerpen met een vloeistof erin, zoals een bloemenvaas, op het apparaat.
- Als de schakelaar op OFF staat, is het apparaat niet volledig losgekoppeld van de netspanning (MAINS).
- De apparatuur wordt in de buurt van het stopcontact geïnstalleerd, zodat dit altijd gemakkelijk toegankelijk is.
- Raak hete gedeelten van het apparaat niet aan tijdens en onmiddellijk na het gebruik.
- Tijdens en onmiddellijk na het gebruik is dit product heet, behalve in de omgeving van de bedieningstoetsen en de aansluitingen op het achterpaneel. Raak geen hete plekken aan, vooral niet het bovenpaneel. Contact met hete plekken kan brandwonden veroorzaken.

## **Español**

### **ADVERTENCIAS**

- No exponga el equipo a la lluvia ni a la humedad.
- No extraiga la tapa del equipo.
- No introduzca nada en el interior del equipo a través de los orificios de ventilación.
- No maneje el cable de alimentación con las manos mojadas.
- No cubra la ventilación con objetos como manteles, periódicos, cortinas, etc.
- No deben colocarse sobre el equipo elementos con fuego, por ejemplo velas encendidas.
- Cuando se eliminen baterías usadas, deben cumplirse las reglamentaciones oficiales o las normas de protección medioambiental aplicables en su país o en su zona.
- Deje un espacio de unos 0,2 metro alrededor de la unidad.

- No se deben colocar sobre el aparato recipientes que contengan líquidos, como por ejemplo jarrones.
- Cuando el interruptor está en la posición OFF, el equipo no está completamente desconectado de la alimentación MAINS.
- El equipo se instalará cerca de la fuente de alimentación de manera que resulte fácil acceder a ella.
- No tocar las áreas calientes mientras la unidad está en uso ni inmediatamente después.
- Mientras esta en funcionamiento e inmediatamente después de su uso, este producto presenta zonas calientes en diversas partes, no exclusivamente en el sector de los controles o en las conexiones del panel posterior. No tocar las áreas calientes, especialmente el panel superior dado que pueden producirse quemaduras.

## **Italiano**

### **AVVERTENZE**

- Non esporre l'apparecchio alla pioggia o all'umidità.
- Non rimuovere il coperchio dell'apparecchio.
- Non introdurre oggetti all'interno dell'apparecchio attraverso i fori di ventilazione.
- Non toccare il cavo di alimentazione con le mani bagnate.
- Non coprire le fessure di ventilazione con tovaglie, giornali, tende od oggetti analoghi.
- Non posare sull'apparecchio sorgenti di fiamme scoperte quali candele accese.
- Smaltire le pile usate in conformità alle norme governative o disposizioni ambientali vigenti nel proprio paese o zona.
- Lasciare 0,2 metro liberi tutto intorno l'unità.
- Non mettere sull'apparecchiatura alcun contenitore di liquido, come ad esempio dei vasi.
- Quando l'interruttore è nella posizione OFF, l'apparecchiatura non è completamente scollegata da MAINS.
- L'apparecchio va installato in prossimità della fonte di alimentazione, in modo che quest'ultima sia facilmente accessibile.
- Non toccare i punti caldi né durante, né immediatamente dopo l'uso.
- Durante, e subito dopo l'utilizzo, questo prodotto risulta essere molto caldo in alcune sue parti come ad esempio i connettori del pannello posteriore. Non toccare i punti caldi e specialmente la superficie del pannello. Il contatto con parti calde può provocare ustioni.

## **Svenska**

### **VARNINGAR**

- Utsätt inte utrustningen för regn eller fukt.
- Ta inte bort utrustningens hölje.
- För inte in föremål i utrustningen genom ventilationshålen.
- Hantera inte nätsladden med våta händer.
- Täck inte för ventilationsöppningarna med några föremål som till exempel bordsdukar, dagstidningar, gardiner e.d.
- Inga föremål med öppen låga, som till exempel tända stearinljus, bör placeras på utrustningen.
- Följ de lagar och miljöskyddsråd som gäller i det land eller område där du bor när du gör dig av med batterier.
- Se till att det finns omkring 0,2 meter fri plats runt omkring enheten.
- Inga objekt som är fyllda med någon vätska, till exempel blomstervaser, bör placeras på apparaten.
- Även om strömbrytaren står i det avstängda läget OFF, så är utrustningen inte helt bortkopplad från det elektriska nätet (MAINS).
- Utrustningen ska vara installerad nära strömuttaget så att strömförsörjningen är lätt att tillgå.
- Vidrör inte varma punkter under och omedelbart efter användning.
- Bortsett från kontrollerna och anslutningsuttagen på baksidan är den här produkten varm under och omedelbart efter användning. Vidrör inte varma punkter och särskilt inte ovansidan. Kontakt med varma ytor kan orsaka brännskador.

# TABLE OF CONTENTS

<b>FOREWORD</b> .....	<b>2</b>	<b>SETUP</b> .....	<b>25</b>	<b>BASIC OPERATION (TUNER)</b> .....	<b>52</b>
EQUIPMENT MAINS WORKING SETTING.....	2	ONSCREEN DISPLAY MENU SYSTEM .....	25	LISTENING TO THE TUNER.....	52
COPYRIGHT .....	2	1 INPUT SETUP .....	27	PRESET MEMORY .....	53
<b>INTRODUCTION</b> .....	<b>2</b>	2 SPKR (SPEAKER) SETUP .....	30	RDS OPERATION .....	55
<b>A NOTE ABOUT RECYCLING</b> .....	<b>2</b>	ERROR MESSAGES .....	33	<b>MULTI ROOM SYSTEM</b> .....	<b>56</b>
<b>DESCRIPTION</b> .....	<b>2</b>	3 SURROUND SETUP .....	36	MULTI ROOM PLAYBACK USING THE MULTI ROOM	
<b>FEATURES</b> .....	<b>5</b>	4 VIDEO SETUP .....	38	OUT TERMINALS.....	56
<b>ACCESSORIES</b> .....	<b>5</b>	5 PREFERENCE .....	39	MULTI ROOM PLAYBACK USING THE MULTI SPEAKER	
<b>FRONT PANEL</b> .....	<b>6</b>	6 ACOUSTIC EQ .....	41	TERMINALS .....	56
FL DISPLAY AND INDICATOR .....	7	<b>BASIC OPERATION (PLAY BACK)</b> .....	<b>43</b>	OPERATION OF THE MULTI ROOM OUTPUTS WITH	
<b>REAR PANEL</b> .....	<b>8</b>	SELECTING AN INPUT SOURCE.....	43	THE REMOTE CONTROL FROM MULTI ROOM .....	57
<b>REMOTE CONTROL OPERATION</b> .....	<b>9</b>	SELECTING THE SURROUND MODE.....	43	<b>TROUBLESHOOTING</b> .....	<b>58</b>
FUNCTION AND OPERATION .....	9	ADJUSTING THE MAIN VOLUME .....	43	HDMI .....	59
OPERATION OF REMOTE CONTROL UNIT .....	11	NIGHT MODE.....	43	<b>TECHNICAL SPECIFICATIONS</b> .....	<b>60</b>
GENERAL INFORMATION OF RC5001SR TO SR6001 12		ADJUSTING THE TONE (BASS & TREBLE) CONTROL	43	<b>DIMENSIONS</b> .....	<b>60</b>
CONTROLLING MARANTZ COMPONENTS .....	13	DIALOGUE NORMALIZATION MESSAGE .....	43		
BASIC OPERATION .....	15	VIDEO CONVERT .....	44		
<b>CONNECTIONS</b> .....	<b>17</b>	I/P CONVERT .....	44		
SPEAKER PLACEMENT .....	17	TEMPORARILY TURNING OFF THE SOUND .....	44		
CONNECTING SPEAKERS.....	17	<b>SURROUND MODE</b> .....	<b>45</b>		
CONNECTING AUDIO COMPONENTS.....	18	SURROUND .....	45		
CONNECTING VIDEO COMPONENTS.....	20	SOURCE DIRECT .....	45		
ADVANCED CONNECTING .....	21	PURE DIRECT .....	45		
CONNECTING THE REMOTE CONTROL JACKS.....	21	<b>OTHER FUNCTION</b> .....	<b>49</b>		
CONNECTING THE ANTENNA TERMINALS .....	22	TV AUTO ON/OFF FUNCTION.....	49		
CONNECTING FOR THE MULTI ROOM .....	23	ATTENUATION TO ANALOG INPUT SIGNAL .....	49		
CONNECTING OTHER EQUIPMENT .....	24	LISTENING THROUGH HEADPHONES .....	49		
		DOLBY HEADPHONE MODE .....	49		
		VIDEO ON/OFF .....	49		
		SELECTING ANALOG AUDIO INPUT OR DIGITAL AUDIO			
		INPUT .....	50		
		RECORDING AN ANALOG SOURCE .....	50		
		SPEAKER A/B .....	50		
		DISPLAY MODE .....	50		
		7.1 CH INPUT.....	51		
		AUX2 INPUT.....	51		
		LIP.SYNC .....	51		

## FOREWORD

This section must be read before any connection is made to the mains supply.

### EQUIPMENT MAINS WORKING SETTING

Your Marantz product has been prepared to comply with the household power and safety requirements that exist in your area. SR6001 can be powered by 230V AC only.

### COPYRIGHT

Recording and playback of any material may require consent. For further information refer to the following:

- Copyright Act 1956
- Dramatic and Musical Performers Act 1958
- Performers Protection Acts 1963 and 1972
- Any subsequent statutory enactments and orders

### CAUTIONS ON INSTALLATION

For heat dispersal, leave at least 0.2 m/8 inch of space between the top, back and sides of this unit and the wall or other components.

- Do not obstruct the ventilation holes.

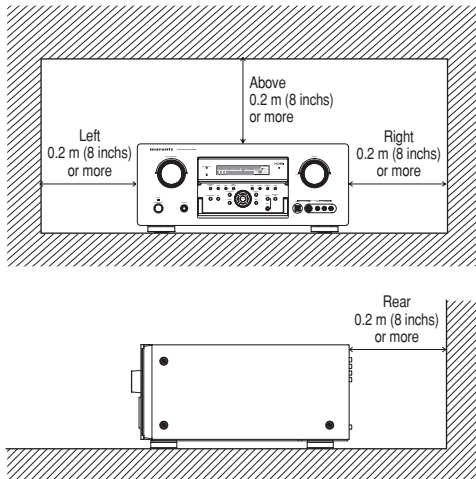

## INTRODUCTION

Thank you for purchasing the Marantz SR6001 Surround receiver.

This remarkable component has been engineered to provide you with many years of home theater enjoyment. Please take a few minutes to read this manual thoroughly before you connect and operate the SR6001.

As there are a number of connection and configuration options, you are encouraged to discuss your own particular home theater setup with your Marantz A/V specialist dealer.

## A NOTE ABOUT RECYCLING



This product's packaging materials are recyclable and can be reused. This product and the accessories packed together are the applicable product to the WEEE directive except batteries.

Please dispose of any materials in accordance with your local recycling regulations.

When discarding the unit, comply with your local rules or regulations.

Batteries should never be thrown away or incinerated but disposed of in accordance with your local regulations concerning chemical wastes.

## DESCRIPTION



DTS was introduced in 1994 to provide 5.1 channels of discrete digital audio into home theater systems. DTS brings you premium quality discrete multichannel digital sound to both movies and music. DTS is a multichannel sound system designed to create full range digital sound reproduction.

The no compromise DTS digital process sets the standard of quality for cinema sound by delivering an exact copy of the studio master recordings to neighborhood and home theaters.

Now, every moviegoer can hear the sound exactly as the moviemaker intended.

DTS can be enjoyed in the home for either movies or music on of DVD's, LD's, and CD's.

"DTS" and "DTS Digital Surround" are registered trademarks of Digital Theater Systems, Inc.



The advantages of discrete multichannel systems over matrix are well known.

But even in homes equipped for discrete multichannel, there remains a need for high-quality matrix decoding. This is because of the large library of matrix surround motion pictures available on disc and on VHS tape; and analog television broadcasts.

The typical matrix decoder of today derives a center channel and a mono surround channel from two-channel matrix stereo material. It is better than a simple matrix in that it includes steering logic to improve separation, but because of its mono, band-limited surround it can be disappointing to users accustomed to discrete multichannel.

Neo:6 offers several important improvements as follow,

- Neo:6 provides up to six full-band channels of matrix decoding from stereo matrix material. Users with 6.1 and 5.1 systems will derive six and five separate channels, respectively, corresponding to the standard home-theater speaker layouts.
- Neo:6 technology allows various sound elements within a channel or channels to be steered separately, and in a way which follows naturally from the original presentation.

- Neo:6 offers a music mode to expand stereo nonmatrix recordings into the five- or six-channel layout, in a way which does not diminish the subtlety and integrity of the original stereo recording.



DTS-ES Extended Surround is a new multichannel digital signal format developed by Digital Theater Systems Inc. While offering high compatibility with the conventional DTS Digital Surround format, DTS-ES Extended Surround greatly improves the 360-degree surround impression and space expression thanks to further expanded surround signals. This format has been used professionally in movie theaters since 1999.

In addition to the 5.1 surround channels (FL, FR, C, SL, SR and LFE), DTS-ES Extended Surround also offers the SB (Surround Back) channel for surround playback with a total of 6.1 channels. DTS-ES Extended Surround includes two signal formats with different surround signal recording methods, as DTS-ES Discrete 6.1 and DTS-ES Matrix 6.1.

"DTS", "DTS-ES" and "Neo:6" are trademarks of Digital Theater Systems, Inc.



The stereo CD is a 16-bit medium with sampling at 44.1 kHz. Professional audio has been 20- or 24-bit for some time, and there is increasing interest in higher sampling rates both for recording and for delivery into the home. Greater bit depths provide extended dynamic range. Higher sampling rates allow wider frequency response and the use of anti-alias and reconstruction filters with more favorable aural characteristics.

DTS 96/24 allows for 5.1 channel sound tracks to be encoded at a rate of 96kHz/24bits on DVD-Video titles.

When DVD-video appeared, it became possible to deliver 24-bit, 96 kHz audio into the home, but only in two channels, and with serious limitations on picture. This capability has had little use.

DVD-audio allows 96/24 in six channels, but a new player is needed, and only analog outputs are provided, necessitating the use of the D/A converters and analog electronics provided in the player.



DTS 96/24 offers the following:

1. Sound quality transparent to the original 96/24 master.
2. Full backward compatibility with all existing decoders. (Existing decoders will output a 48 kHz signal)
3. No new player required: DTS 96/24 can be carried on DVD-video, or in the video zone of DVD-audio, accessible to all DVD players.
4. 96/24 5.1-channel sound with full-quality full-motion video, for music programs and motion picture soundtracks on DVD-video.

“DTS” and “DTS 96/24” are trademarks of Digital Theater Systems, Inc.



Dolby Digital identifies the use of Dolby Digital audio coding for such consumer formats as DVD and DTV. As with film sound, Dolby Digital can provide up to five full-range channels for left, center, and right screen channels, independent left and right surround channels, and a sixth (“.1”) channel for low-frequency effects.

Dolby Surround Pro Logic II is an improved matrix decoding technology that provides better spatiality and directionality on Dolby Surround program material; provides a convincing three-dimensional soundfield on conventional stereo music recordings; and is ideally suited to bring the surround experience to automotive sound. While conventional surround programming is fully compatible with Dolby Surround Pro Logic II decoders, soundtracks will be able to be encoded specifically to take full advantage of Pro Logic II playback, including separate left and right surround channels. (Such material is also compatible with conventional Pro Logic decoders.)

Dolby Digital EX creates six full-bandwidth output channels from 5.1-channel sources. This is done using a matrix decoder that derives three surround channels from the two in the original recording. For best results, Dolby Digital EX should be used with movies soundtracks recorded with Dolby Digital Surround EX.

**About Dolby Pro Logic IIx**

Dolby Pro Logic IIx technology delivers a natural and immersing 7.1-channel listening experience to the home theater environment. A product of Dolby’s expertise in surround sound and matrix decoding technologies, Dolby Pro Logic IIx is a complete surround sound solution that maximizes the entertainment experience from stereo as well as 5.1-channel encoded sources.

Dolby Pro Logic IIx is fully compatible with Dolby Surround Pro Logic technology and can optimally decode the thousands of commercially available Dolby Surround encoded video cassettes and television programs with enhanced depth and spatiality. It can also process any high-quality stereo or Advanced Resolution 5.1-channel music content into a seamless 6.1- or 7.1-channel listening experience.



The Dolby Headphone technology provides a surround sound listening experience over headphones. When listening to multichannel content such as DVD movies over headphones, the listening experience is fundamentally different than listening to speakers. Since the headphone speaker drivers are covering the pinna of the ear, the listening experience differs greatly from traditional speaker playback. Dolby utilizes patented headphone perspective curves to solve this problem and provides a non-fatiguing, immersive, home theater listening experience. Dolby Headphone also delivers exceptional 3D audio from stereo material.



Dolby Virtual Speaker is a technology certified by Dolby Laboratories that creates a virtualized surround sound experience from two speakers using a multichannel Dolby Digital source. Additionally, Dolby Virtual Speaker can simulate the surround sound effect produced by Dolby Pro Logic or Dolby Pro Logic II.

Dolby Virtual Speaker retains all the original Multichannel audio information and provides the listener with the sensation of being surrounded by additional speakers.

Manufactured under license from Dolby Laboratories. “Dolby”, “Pro Logic”, and the double-D symbol are trademarks of Dolby Laboratories.



Circle Surround II (CS-II) is a powerful and versatile multichannel technology. CS-II is designed to enable up to 6.1 multichannel surround sound playback from mono, stereo, CS encoded sources and other matrix encoded sources. In all cases the decoder extends it into 6 channels of surround audio and a LFE/subwoofer signal. The CS-II decoder creates a listening environment that places the listener “inside” music performances and dramatically improves both hi-fi audio conventional surround-encoded video material. CS-II provides composite stereo rear channels to greatly improve separation and image positioning— adding a heightened sense of realism to both audio and A/V productions.

CS-II is packed with other useful feature like dialog clarity (SRS Dialog) for movies and cinema-like bass enrichment (TruBass). CS-II can enable the dialog to become clearer and more discernable in movies and it enables the bass frequencies contained in the original programming to more closely achieve low frequencies—overcoming the low frequency limitations of the speakers by full octave.

Circle Surround II, Dialog Clarity, TruBass, SRS and  symbol are trademarks of SRS Labs, Inc. Circle Surround II, Dialog Clarity and TruBass technology are incorporated under license from SRS Labs, Inc.



HDCD® (High Definition Compatible Digital ®) is a patented process for delivering on Compact Disc the full richness and details of the original microphone feed.

HDCD encoded CDs sound better because they are encoded with 20-bits of real musical information as compared to 16-bits for all other CDs.

HDCD overcomes the limitation of the 16-bit CD format by using a sophisticated system to encode the additional four bits onto the CD while remaining completely compatible with the CD format.

When listening to HDCD recordings, you hear more dynamic range, a focused 3-D sound stage, and extremely natural vocal and musical timbre. With HDCD, you get the body, depth and emotion of the original performance not a flat, digital imitation.

HDCD system manufactured under license from Microsoft. This product is covered by one or more of the following: In the United States 5,479,168 5,638,074 5,640,161 5,808,574 5,838,274 5,854,600 5,864,311 5,872,531 and in Australia 669,114 with other patents pending.

**HDMI**

HDMI, the **HDMI** and High-Definition Multimedia Interface are trademarks or registered trademarks of HDMI Licensing LLC.



There are several factors that can degrade the sound from even the best loudspeakers in a listening room. One of the most important is the interaction of sound from the loudspeakers with large surfaces such as walls, the floor, and the ceiling in the room. Even with careful loudspeaker placement and acoustical treatments, there are significant problems that are caused by room acoustics. These include reflections from nearby surfaces and standing waves that are created between large parallel surfaces in the room. In a home theater the situation is further complicated because there are several listening locations. The effects of room acoustics on the sound arriving at each person's ears are very different and the result is a listening experience that is degraded in a different way for every person in the room. It is not uncommon to have variations in two adjacent seats that are as large as 10 dB, particularly in the frequency range below 250 Hz.

The solution to this problem is to apply room correction after precisely measuring how each loudspeaker interacts with the room. Because the room causes variations in the frequency response of the loudspeakers that are so large from seat to seat, it is important to measure each loudspeaker at several locations in the listening room. This should be done even if there is only one listener. Measurement at a single location is not representative of the acoustical problems in the room and will in most cases, degrade overall performance. Audyssey MultEQ is the only technology that can achieve room correction for multiple listeners in a large listening area. It does so by combining the data collected at several points in the room from each loudspeaker and then applying correction that minimizes the acoustical effects of the room and is matched to the frequency resolution of human perception (known as psychoacoustics). Furthermore, MultEQ correction is applied both in frequency and time domains and so there are no artifacts (such as smearing of sound or modal ringing) that are sometimes associated with traditional methods of room equalization.

In addition to correcting frequency response problems over a wide listening area, Audyssey MultEQ provides a completely automated sound system set-up process. It identifies how many loudspeakers are connected to the amplifiers and whether they are full-range, satellites, or subwoofers. If there is a least one subwoofer connected, Audyssey MultEQ determines the optimum crossover frequency between each satellite and the subwoofer(s). It automatically checks the polarity of each loudspeaker and alerts the user if there are any that may be wired

out-of-phase relative to the others. It measures the distance to each loudspeaker from the main listening position and adjusts the delays so that sound from each loudspeaker arrives at the same time. Finally, Audyssey MultEQ determines the playback level of each loudspeaker and adjusts the volume trims so that all levels are equal.



MultEQ and the Audyssey MultEQ logo are trademarks of Audyssey Laboratories, Inc. All rights reserved.



## FEATURES

The SR6001 incorporates the latest generation of digital surround sound decoding technology such as Dolby Digital EX, Dolby Digital, DTS ES (Discrete 6.1 and Matrix 6.1), DTS Neo:6 (Cinema, Music), Dolby Pro-Logic II (Movie, Music and Game), Dolby Pro-Logic IIx (Movie, Music and Game), Circle Surround II (Cinema, Music and Mono).

In addition, Marantz has focused on the future. By utilizing pre-out jacks, 7.1 direct inputs and a RS-232C communication port, the SR6001 is tomorrow's technology, today!

The SR6001 incorporates the most advanced Digital Signal Processing circuitry, along with a 192 kHz/24 bit D/A converter in each of the 7 channels. Independent power supply circuits are incorporated for the FL display, audio and video sections for maximum separation, clarity and dynamic range. Together with hand-selected customized components, all elements work in harmony to recreate the emotion, exactly as the artist had intended.

The SR6001 is designed and engineered with extensive feedback from custom installation experts, dealers and consumers. It features multi-room/multisource, assignable DC trigger, a RS-232C communication port, Flasher input, heavy duty speaker binding posts and an extensive array of both analog and digital inputs / outputs. With 5 assignable digital inputs (6 total), 4 component inputs, Super Audio CD Multi Channel (7.1 channel) direct inputs, video convert system and a speaker-B and OSD output versatility is taken to a stunning new level. Furthermore, the SR6001 can output the OSD information through the Y/C (S-video) and composite video outputs.

An easy-to-use programmable, learning remote control allows full access to all of the operating functions and can be used for system operation as well.

The new generation of Marantz Receivers is stylish and completely symmetrical. On the front panel of the SR6001, buttons are kept to a minimum. Source selectors and volume controls are intuitively placed. The SR6001 is here to perform in your unrivaled home entertainment setup.

### • HDMI

HDMI (High-Definition Multimedia Interface) is an enhancement to the DVI (Digital Visual Interface) standard. It adds capabilities for digitally transmitting audio signals in addition to video signals. Where multiple cables were previously needed for audio/video, HDMI enables audio/video connection via a single cable.

The HDMI input jacks of this receiver support HDMI Ver. 1.2. and the HDMI output jacks of this transmitter support HDMI Ver. 1.1.

Ver. 1.2 supports 1-bit audio formatting and enables transmission of DSD (Direct Stream Digital) signals of Super Audio CD.

### Copyright Protection

This receiver supports HDCP (High-bandwidth Digital Content Protection). HDCP is copyright protection technology that consists of data encoding and other device authentication. Its purpose is to protect digital video content. Both this receiver and the connected component (such as a video player or monitor) must support HDCP. Before connecting a component to this receiver, refer to its instruction manual.

- Dolby Digital EX, Dolby Digital, DTS ES (Discrete 6.1, Matrix 6.1, Neo:6)
- Dolby Pro Logic II (Movie, Music, Game)
- Dolby Pro Logic IIx (Movie, Music, Game)
- Circle Surround II (Cinema, Music, Mono)
- Audyssey Mult EQ
- 7 × 100 Watts (8 Ohms), Discrete Amplifiers
- High Power Current Feedback Circuitry
- Massive Energy Power Supply, Huge EI Transformer, Large ELCO's.
- 192 kHz/24 bit DAC for all 8 Channels
- 32 bit Digital Surround Processing Chipsets
- Video Off Mode
- Large Heavy Duty Speaker Terminals for all Channels
- RS-232C Terminal for Future Upgrade or System Control
- Set Up Menu via all Video Output (Composite, S-Video, Component video and HDMI)
- Auto Input Signal Detection
- Improved Station Name Input Method, 60 Presets
- Auto Adjust Function for Speaker Distance Settings (Delay Time)
- Front Optical AUX Input (Digital Camera, Portable DVD)
- Programmable, learning remote control
- Video convert system  
HDMI ← Component Video ↔ S-Video ↔ Composit Video
- Video I/P Converter
- Assignable Video Input
- Lip Sync (Audio Delay)

- Function Rename
- HDCP
- Dolby Headphone
- Bi-amp drive
- Source/Pure Direct mode
- 9 bands x 7 ch GEQ
- DSD direct conversion
- DSD to PCM converter
- Assignable DC Trigger Output
- Flasher Input

## ACCESSORIES

### Remote Controller RC5001SR

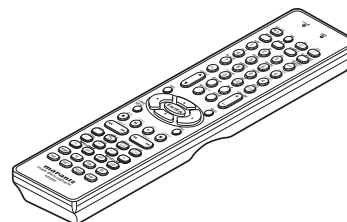

### AAA-size batteries × 2

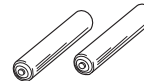

### Microphone

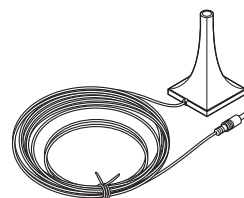

### AC cable

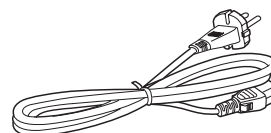

### AM Loop Antenna

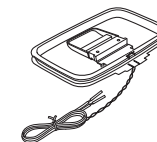

### FM Antenna

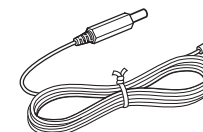

### Front AUX Jack Cover

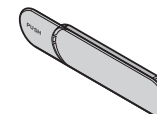

### User Guide

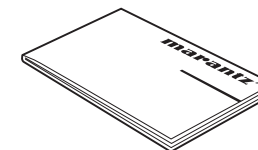

## FRONT PANEL

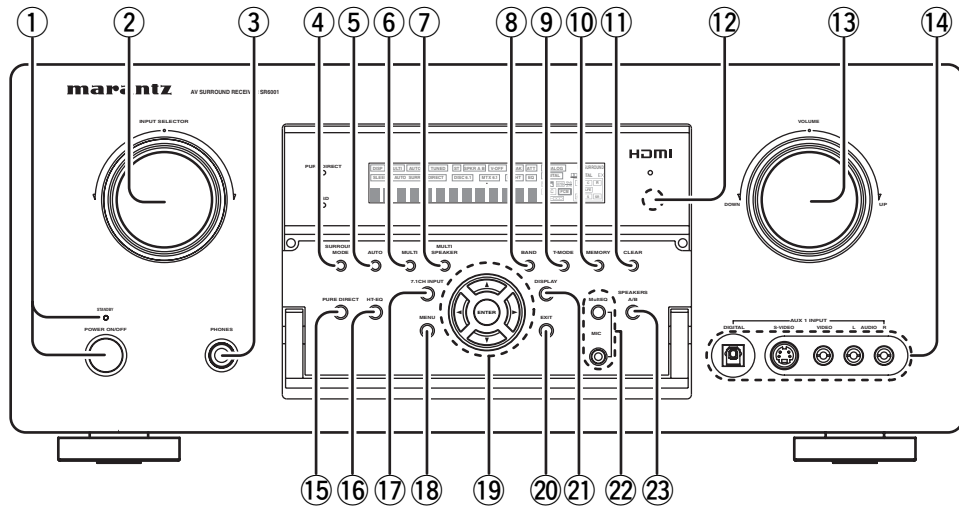

### ① POWER switch and STANDBY indicator

Press the button to turn the power ON, and press again to turn it OFF. If the **POWER** switch is in the ON position, the power of this unit can be turned ON/OFF by pressing the **POWER** button on the remote control unit.

When this unit is in the standby mode with the **POWER** switch set to the ON position, pressing the **ENTER** button also allows to turn the power on. The **STANDBY** indicator lights up when this unit is the standby mode (power OFF) by the remote control unit.

### ② INPUT SELECTOR knob (AUDIO/VIDEO)

This knob is used to select the input sources.

#### Note:

- When the input source is set to TUNER, it is possible to select the video source separately.

### ③ HEADPHONE jack for stereo headphones

This jack may be used to listen to the SR6001's output through a pair of headphones. Be certain that the headphones have a standard 1/4" stereo phono plug. Note that the main room speakers will automatically be turned off when the headphone jack is in use.

#### Notes:

- When using headphones, the surround mode will change to STEREO and Dolby Headphone by MENU and Cursor button.
- The surround mode returns to the previous setting as soon as the headphone plug is removed from the jack.

### ④ SURROUND MODE button

You can select the surround mode by pressing this button.

### ⑤ AUTO (Auto surround) button

Press this button to select the AUTO mode from the surround modes. When this mode is selected, the receiver determines the surround mode corresponding to a digital input signal automatically.

### ⑥ MULTI (Multi Room) button

Press this button to activate the Multiroom system. "MULTI" indicator will be illuminated in the display. (See page 56)

### ⑦ MULTI SPEAKER button

Press this button to activate the Multiroom Speaker system. "MULTI" indicator will be illuminated in the display. (See page 56)

### ⑧ BAND button

Press this button to switch between FM and AM in the TUNER mode.

### ⑨ T-MODE button

Press this button to select the auto stereo mode or mono mode when the FM band is selected.

The "AUTO" indicator lights in the auto stereo mode. (See page 52)

### ⑩ MEMORY button

Press this button to enter the tuner preset memory numbers or station names. (See page 53)

### ⑪ CLEAR button

Press this button to cancel the station-memory setting mode or preset scan tuning. (See page 54)

### ⑫ INFRARED receiving sensor window

This window receives infrared signals for the remote control.

### ⑬ VOLUME control knob

Adjusts the overall sound level. Turning the control clockwise increases the sound level.

### ⑭ AUX1 INPUT jacks

These auxiliary video/audio input jacks accept the connections of a camcorder, portable DVD, game etc. When not using these jacks, protect with the included jack covers.

#### How to Attach the Front AUX Jack Cover

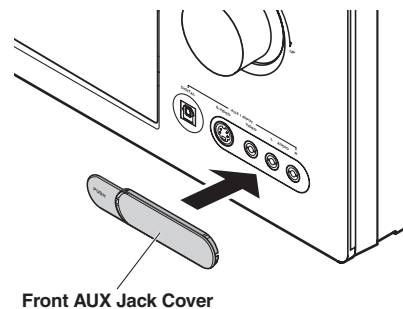

Front AUX Jack Cover

### ⑮ PURE DIRECT button and indicator

When this button is pressed once, "SOURCE DIRECT" appears on the FL display. If pressed again, "PURE DIRECT" appears. After 2 seconds, the FL display indication goes out.

In the source/pure direct mode, the tone control circuitry and bass management are bypassed.

#### Notes:

- The surround mode is automatically switched to AUTO when the pure direct function is turned on.
- Additionally, speaker configurations are fixed automatically as follows.  
Front SPKR = LARGE  
Center SPKR = LARGE  
Surround SPKR = LARGE  
Surround Back SPKR = LARGE  
Sub woofer = YES

### ⑯ HT-EQ button

Press this button to switch between HT-EQ ON/Off.

### ⑰ 7.1CH INPUT button

Press this button to select the output of an external multichannel player.

### ⑱ MENU button

This button is used to enter the SETUP MAIN MENU.

### ⑲ Cursor (▲, ▼, ◀, ▶) / ENTER button

Use these buttons when operating the SETUP MAIN MENU and TUNER function.

### ⑳ EXIT button

This button is used to exit from the SETUP MAIN MENU.

### ㉑ DISPLAY button

When this button is pressed, the FL display mode is changed as Input display → Surround Mode → Auto-display Off → Display Off → Function name display and the display off indicator (DISP) lights up in condition DISPLAY OFF.

### ㉒ MultEQ button / MIC jack

Press to automatically measure speaker characteristics using the included microphone. (See page 31)

## 23 SPEAKER A/B button

Press this button to select speaker systems A and/or B.

### Opening and closing the front panel door

When you want to use the controls behind the front panel door, open the door by gently pressing on the lower part of the panel. Keep the door closed when not using these controls.

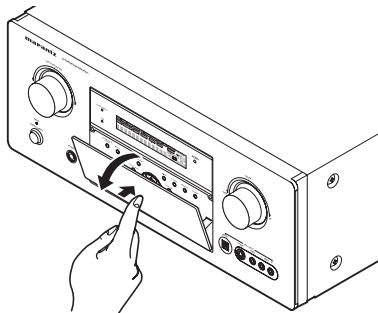

### Caution:

- Be careful not to pinch your fingers between the door and the panel.

## FL DISPLAY AND INDICATOR

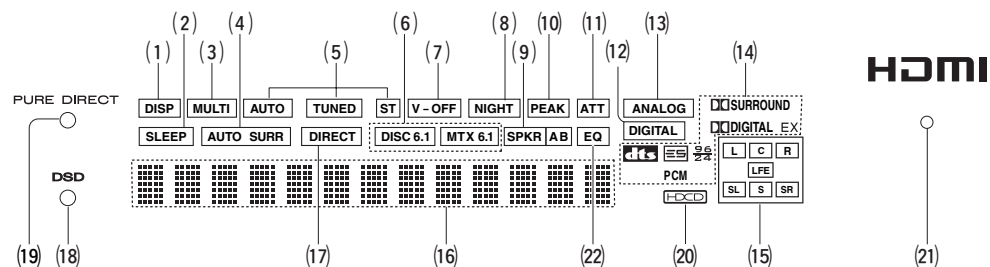

### (1) DISP (Display Off) indicator

This indicator is illuminated when the SR6001 is in the display off condition.

### (2) SLEEP timer indicator

This indicator is illuminated when the sleep timer function in the main-room is in use.

### (3) Multi-room system indicator

This indicator is illuminated when the multi-room system is active.

### (4) AUTO SURR (Auto Surround mode) indicator

This indicator is illuminated to show that the AUTO SURROUND mode is in use.

### (5) TUNER's indicators

**AUTO**: This indicator illuminates when the tuner's Auto mode is in use.

**TUNED**: This indicator illuminates when a station is being received with sufficient signal strength to provide acceptable listening quality.

**ST(Stereo)**: This indicator illuminates when an FM station is being tuned into stereo condition.

### (6) DTS-ES mode indicators (DISC6.1, MTX6.1)

These indicators will illuminate to show the DTS-ES decoding mode (Discrete 6.1 or Matrix 6.1).

### (7) V (video)-OFF mode indicator

This indicator is illuminated when the Video-OFF function is active.

### (8) NIGHT mode indicator

This indicator is illuminated when the SR6001 is in the Night mode, which reduces the dynamic range of digital program material at low volume levels.

### (9) SPKR (speaker) AB indicator

Active speaker system will be illuminated by this indicator.

### (10) PEAK indicator

This indicator is a monitor for an analog audio input signal. If the selected analog audio input signal is greater than the capable level of internal processing, this will illuminate. If this happens, you should press the **ATT** button on the remote. (See page 10)

### (11) ATT (Attenuation) indicator

This indicator is illuminated when the attenuation function is active.

### (12) DIGITAL Input Indicator

This indicator lights when a digital input has been selected.

### (13) ANALOG input indicator

This indicator is illuminated when an analog input source has been selected.

### (14) SIGNAL FORMAT indicators

#### DIGITAL

This indicator is illuminated when a Dolby Digital signal is input.

#### EX

This indicator is illuminated when a Dolby Digital EX signal is input.

#### dts

This indicator is illuminated when a DTS signal is input.

#### ES

This indicator is illuminated when a DTS ES signal is input.

#### 96/24

This indicator is illuminated when a DTS 96/24 signal is input.

## PCM

This indicator is illuminated when the input signal is PCM (pulse code modulation).

## DOLBY SURROUND

This indicator is illuminated when a Dolby Surround signal is input.

### (15) ENCODED CHANNEL STATUS indicators

These indicators display the channels that are encoded with a digital input signal. If the selected digital input signal is Dolby Digital 5.1ch or DTS 5.1ch, "L", "C", "R", "SL", "SR" and "LFE" will be illuminated. If the digital input signal is 2 channel PCM-audio, "L" and "R" will be displayed.

If Dolby Digital 5.1ch signal with Surround EX flag or DTS-ES signal comes in, "L", "C", "R", "SL", "S", "SR" and "LFE" will be illuminated.

### (16) Main Information Display

This display shows messages relating to the status, input source, surround mode, tuner, volume level or other aspects of unit's operation.

### (17) SOURCE DIRECT indicator

This indicator is illuminated when the SR6001 is in the SOURCE DIRECT mode.

### (18) DSD indicator

This indicator illuminates when a DSD (Direct Stream Digital) signal of an Super Audio CD is input via the audio signal included in the HDMI input signal.

### (19) PURE DIRECT indicator

This indicator is illuminated when the SR6001 is in the PURE DIRECT mode.

### (20) HDCD indicator

When HDCD signal is decoded, this indicator will light up.

### (21) HDMI indicator

This indicator illuminates when an HDMI device is connected to the input and a link is established.

### (22) EQ indicator

This indicator is illuminated when the EQ MODE is selected to "AUDDYSSEY", "FRONT" or "FLAT".



# REAR PANEL

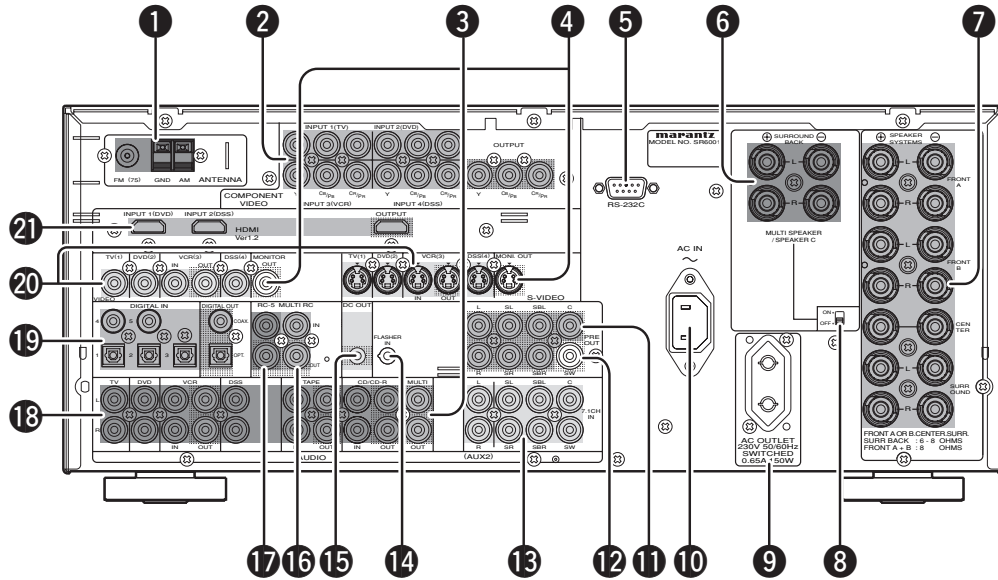

## 1 FM antenna terminal (75 ohms)

Connect an external FM antenna with a coaxial cable, or a cable network FM source.

## AM antenna and ground terminals

Connect the supplied AM loop antenna. Use the terminals marked "AM" and "GND". The supplied AM loop antenna will provide good AM reception in most areas. Position the loop antenna until you hear the best reception.

## 2 COMPONENT VIDEO INPUT/OUTPUT

If your DVD player or other device has component video connectors, be sure to connect them to these component video connectors on the SR6001. The SR6001 has 4 component video input connectors to obtain the color information (Y, C<sub>B</sub>, C<sub>R</sub>) directly from the recorded DVD signal or other video component, and 1 component video output connector to output the information directly into the matrix decoder of the display device.

By sending the pure DVD component video signal directly, the DVD signal forgoes the extra processing that normally would degrade the image. The result is vastly increased image quality, with incredibly life like colors and crisp detail.

## 3 Multiroom Output (Audio output)

This is the audio output jack for the Multi zone (Multi room).

Connect these jacks to optional audio power amplifiers to listen the source selected by the multiroom system in a remote room.

## 4 MONITOR OUT

These are monitor outputs and each one includes both composite video and S-video configurations. When connecting two video monitors or televisions, be aware that the OSD interface can be used with both MONITOR OUT connections.

## 5 RS-232C

The RS-232C port is to be used in conjunction with an external controller to control the operation of the SR6001 by using an external device.

The RS-232C port may also be used in the future to update the operating software of the SR6001 so that it will be able to support new digital audio formats and the like as they are introduced.

## 6 Speaker outputs terminals (SURROUND BACK / MULTI SPEAKER / SPEAKER C)

Two terminals are provided for the front left, and right speakers for multi room (2nd zone) or surround back.

The terminals can be used to connect a third set of speakers by setting the SPEAKER C selector switch to ON. For connection and use, see page 23.

## 7 Speaker outputs terminals

Seven terminals are provided for the front (A) left, front (A) right, front (B) left, front (B) right, front center, surround left, and surround right speakers.

## 8 SPEAKER C switch

Set to ON to connect a bi-amp to this receiver or set to OFF for normal speaker connection (surround back and multiroom speakers). (See page 23)

## 9 AC OUTLETS

Connect the AC power cables of components such as a DVD and CD player to these outlets. SWITCHED terminal is provided.

The one marked SWITCHED provides power only when the SR6001 is turned on and is useful for components which you use every time you play your system.

### Caution:

- In order to avoid potential turn-off thumps, anything plugged into these outlets should be powered up before the SR6001 is turned on.
- The capacity of this AC outlet is 150W. Do not connect devices that consume electricity more than the capacity of these AC outlets. If the total power consumption of the connected devices exceeds the capacity, the protection circuit shuts down the power supply.

## 10 AC INLET

Plug the supplied power cord into this AC INLET and then into the power outlet on the wall.

SR6001 can be powered by 230V AC only.

## 11 Preamp Outputs (L, R, SL, SR, SBL, SBR, C)

Jacks for L (front left), R (front right), C (Center), SL (surround left), SR (surround right), SBL (surround back left) and SBR (surround back right).

Use these jacks for connection to external power amplifiers.

## 12 Subwoofer Output

Connect this jack to the line level input of a powered subwoofer. If an external subwoofer amplifier is used, connect this jack to the subwoofer amplifier input. If you are using two subwoofers, either powered or with a 2 channel subwoofer amplifier, connect a "Y" connector to the subwoofer output jack and run one cable from it to each subwoofer amplifier.

## 13 7.1 CHANNEL or AUX2 INPUT

By connecting a DVD Audio player, Super Audio CD multichannel player, or other components that has a multichannel port, you can playback the audio with 5.1 channel or 7.1 channel outputs.

## 14 FLASHER IN (Flasher input terminal)

These terminals are to control the unit from each zone. Connect the control signal from a Keypad, etc.

## 15 DC TRIGGER output terminal

Connect a device that needs to be triggered by DC under certain conditions (screen, power strip, etc...) Use the system OSD setup menu to determine the conditions by which these jack will be active.

### Note:

- This output voltage is for (status) control only, It is not sufficient for drive capability.

## 16 MULTI ROOM REMOTE IN/OUT terminals

IN: Connect to a multi-room remote control device, available from your Marantz dealer.  
OUT: Connect to the Marantz component equipped with remote control (RC-5) terminals in Multi zone (Multi room).

## 17 REMOTE CONT. IN/OUT terminals

Connect to a Marantz component equipped with remote control (RC-5) terminals.

## 18 AUDIO IN/OUT (TV, DVD, VCR, DSS, TAPE, CD/CDR)

These are the analog audio inputs and outputs. There are 6 audio inputs and 3 audio outputs. The audio jacks are nominally labeled for cassette tape decks, compact disc players, DVD players and etc.... The audio inputs and outputs require RCA-type connectors.

**19 DIGITAL INPUT (Dig.1 - 5) / OUTPUT (coaxial, optical)**

These are the digital audio inputs and outputs. There are 2 digital inputs with coaxial jacks, 3 with optical jacks.

The inputs accept digital audio signals from a compact disc, LD, DVD, or other digital source component.

For digital output, there is 1 coaxial output and 1 optical output.

The digital outputs can be connected to MD recorders, CD recorders, DAT decks, or other similar components.

**20 VIDEO IN/OUT (TV, DVD, VCR, DSS)**

These are the video inputs and outputs. There are 4 video inputs and 1 video output and each one includes both composite video and S-video configurations. Connect VCRs, DVD players, and other video components to the video inputs.

The 1 video output channel can be used to connected to video tape recorders for making recordings.

**21 HDMI INPUT / OUTPUT**

This unit has 2 HDMI inputs and 1 HDMI output. The input function can be selected from the OSD menu system. (See page 19)

**REMOTE CONTROL OPERATION**

**FUNCTION AND OPERATION**

The provided remote control unit is a universal remote controller. The **POWER** button, numeric buttons and control buttons are used in common across different input source components.

The input source controlled with the remote control unit changes when one of the input selector buttons is pressed.

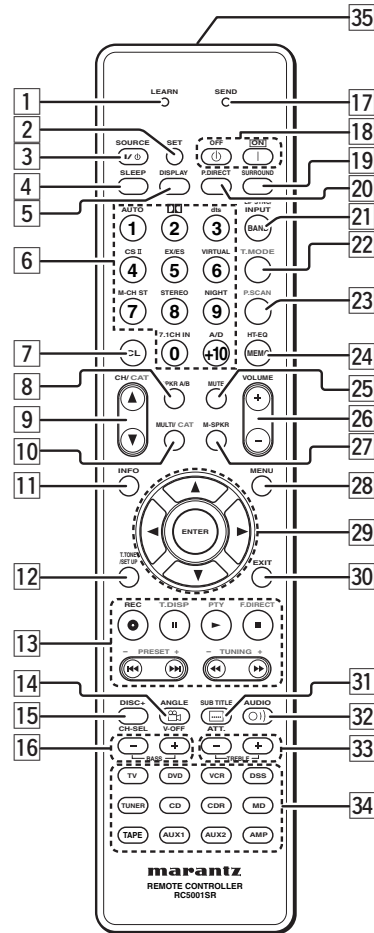

**1 LEARN indicator**

Indicates when the remote controller is in the LEARN mode.

**2 SET button**

This button is used to enter learn mode and preset mode.

**3 SOURCE ON/OFF button**

This button is used to turn a specific source (such as a DVD player) on or off independently from the rest of the system.

**4 SLEEP button**

This button is used for setting the sleep timer.

**5 DISPLAY button**

Selects the display mode for the front display of the SR6001.

**6 Numeric buttons**

These buttons are used to switch between 0 to +10 of the source components. If the source is set to the amplifier, these buttons are used to perform operations.

*(When AMP mode is selected)*

**1/AUTO button**

Used to select auto surround.

**2/Dolby button**

Used to select DOLBY mode.

**3/dts button**

Used to select dts mode.

**4/CSII button**

Used to select CSII mode.

**5/EX/ES button**

Used to select EX/ES mode.

**6/VIRTUAL button**

Used to select VIRTUAL mode.

**7/M-CH ST button**

Used to select Multi Channel Stereo.

**8/STEREO button**

Used to select STEREO mode.

**9/NIGHT button**

Pressing this button prevents the Dolby Digital signal from playback at a loud voice. This function reduces the voice by 1/3 to 1/4 at maximum. Thus, it eliminates the occurrence of an abruptly loud voice at night. However, the function is valid only in the case when the Dolby Digital signal is entered into OPTICAL or COAXIAL and data to compress the voice exists in the signal to be played back.

When this button is pressed, the "NIGHT" indicator is illuminated.

**0/7.1CH IN button**

Press this button to select the output of an external multi channel decoder.

**(+10) A/D button**

Used to switch between the analog and digital inputs.

**7 CL (Clear) button**

This button is used to erase the memory or program of a source.

**8 SPKR A/B button**

Used to select the speaker system.

The speaker system is switched in the following sequence.

A → B → A+B → off

**9 CH/CAT▲ (UP) / ▼ (DOWN) buttons**

These buttons are used to change channels.

**10 MULTI/CAT button**

*(When AMP mode is selected)*

Used to turn on and off multi room.

**11 INFO button**

*(When AMP mode is selected)*

When this button is pressed, the current setting are displayed on the TV monitor.

**12 T.TONE/SET UP button**

*(When AMP mode is selected)*

Used to enter the test tone menu.

**13 CONTROL buttons**

These buttons are used when operating PLAY, STOP, PAUSE and other commands of a source.

*(When TUNER mode is selected)*

**T.DISP button**

Used to select the display mode in RDS.

**PTY button**

Used to display the programme type information of the current station.

**F.DIRECT button**

Used to select the "Frequency direct input".

**PRESET +/- buttons**

Used to select a preset station up and down.

**TUNING +/- buttons**

Used to tune a frequency station up and down.

**14 ANGLE/V-OFF button**

*(When AMP mode is selected)*

Used to turn off the video signal.

**15 DISC+/CH. SEL button**

*(When AMP mode is selected)*

Used to call up SETUP MAIN MENU and adjust speaker levels or 7.1 ch input level.

**16 BASS +/- buttons**

These buttons are used to adjust the tone control of low frequency sound for left, right and subwoofer speaker.

**17 SEND indicator**

Indicates when the remote controller is transmitting a signal.

**18  / | POWER ON and OFF buttons**

*(When AMP mode is selected)*

These buttons are used to turn the SR6001 on or off.

**19 SURROUND button**

This button is used to select the surround mode.

**20 P.DIRECT button**

When this button is pressed, the tone control circuit is bypassed.

**21 BAND/LIP SYNC/INPUT button**

*(When TUNER mode is selected)*

Used to select a radio band.

*(When AMP mode is selected)*

Used to select LIP SYNC mode.

*(When TV mode is selected)*

Used to select monitor input.

**22 T.MODE button**

*(When TUNER mode is selected)*

Used to select auto stereo mode or mono mode when the FM band is selected.

The "AUTO" indicator lights in the auto stereo mode.

**23 P.SCAN button**

*(When TUNER mode is selected)*

Used to start preset scan.

**24 MEMO/HT-EQ button**

This button is used to store setting to memory or program a source.

*(When AMP mode is selected)*

Used to turn on or off HT(Home Theater)-EQ mode. This mode compensates for the audio portion of a movie sounding "bright".

**25 MUTE button**

This button is used to mute the audio for the amplifier and television.

**Note:**

Set the AMP mode to use this button with the SR6001.

**26 VOLUME +/- buttons**

This button is used to adjust the volume for the amplifier and television.

**Note:**

Set the AMP mode to use this button with the SR6001.

**27 M-SPKR button**

*(When AMP mode is selected)*

Used to turn on and off multi speaker.

**28 MENU button**

*(When AMP mode is selected)*

This button is used to call up the SETUP MAIN MENU of the SR6001.

**29  (CURSOR) / ENTER buttons**

These buttons are used when controlling the cursor of the SR6001, DVD or other AV equipment.

**30 EXIT button**

*(When AMP mode is selected)*

This button is used to cancel setting in the setup menu.

**31 SUBTITLE/ATT. button**

*(When AMP mode is selected)*

When the input signal is too high and the voice distorts even by throttling the SR6001 VOLUME control, turn on this function.

"ATT" is indicated when this function is activated.

The input level reduced. Attenuator is invalid for the output signal of "REC OUT".

**Note:**

This function is unavailable while the digital input is selected.

**32 AUDIO buttons**

*(When DVD mode is selected)*

Used to select one of the audio language.

**33 TREBLE +/- buttons**

These buttons are used to adjust the tone control of high frequency sound for left and right speaker.

**34 SOURCE button**

These buttons are used to switch the source of your A/V Receiver / amplifier. Each time a source button is pressed, the remote control changes to the source which was pressed.

This remote control can control 12 types of equipment. To change the A/V Receiver / amplifier source, press this button twice within two seconds. The signal is sent when it is pressed the second time.

**Note:**

Select the AMP as the source to use this remote control with the SR6001.

**35 Infrared Transmitter and Learning Sensor**

This transmitter emits infrared light. Press the buttons while pointing the transmitter towards the infrared receiver window of the SR6001 or other AV equipment. Be sure to also point towards other remote controls when using the learning function.



## OPERATION OF REMOTE CONTROL UNIT

### REMOTE CONTROL

The distance between the transmitter of the remote control and the IR SENSOR of the SR6001 should be less than 5 meters. If the remote control is pointed in a direction other than the IR SENSOR or if there is an obstacle between them, use of the remote control may not be possible.

### Remote-controllable range

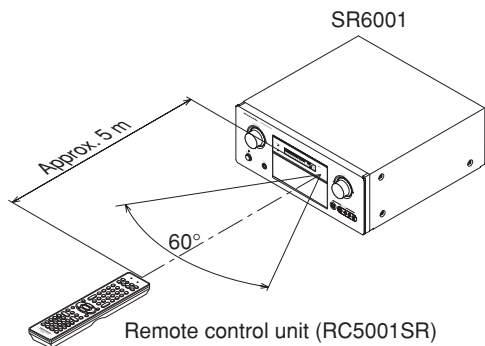

### LOADING BATTERIES

The life of the batteries used with the remote control is about 4 months with normal use. Also be sure to replace batteries earlier when you notice that they are getting weak.

1. Remove the back cover.

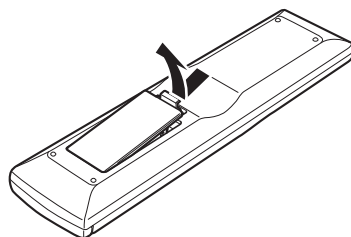

2. Insert the new batteries (AAA type) with correct  $\oplus$  and  $\ominus$  polarity.

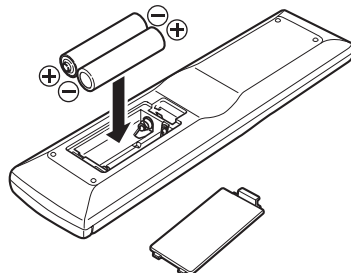

3. Close the cover until it clicks.

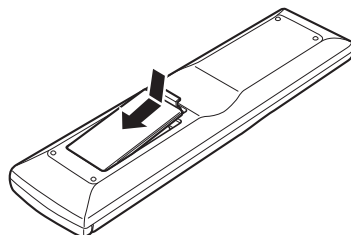

### Notes:

- Do not mix alkaline and manganese batteries.
- Do not mix old and new batteries.

### CAUTIONS ON BATTERIES

- Use “AAA” type batteries in this remote control unit.
- We recommend that you use alkali batteries.
- If the remote control unit does not operate from close to the main unit, replace the batteries with new ones, even if less than a year has passed.
- The included battery is only for verifying operation. Replace it with a new battery as soon as possible.
- When inserting the batteries, be careful to do so in the proper direction, following the + and - marks in the remote control unit’s battery compartment.
- To prevent damage or battery fluid leakage:
  - Do not use a new battery with an old one.
  - Do not use two different types of batteries.
  - Do not short-circuit, disassemble, heat or dispose of batteries in flames.
- Remove the batteries when not planning to use the remote control unit for a long period of time.
- If the batteries should leak, carefully wipe off the fluid from the inside of the battery compartment, then insert new batteries.
- When disposing of used batteries, please comply with governmental regulations or environmental public instruction’s rules that apply in your country or area.

GENERAL INFORMATION OF RC5001SR TO SR6001

To control the SR6001 by your RC5001SR, you have to select the device AMP or TUNER by pressing the **SOURCE** button. Please refer below for the details in AMP and TUNER mode.

AMP MODE

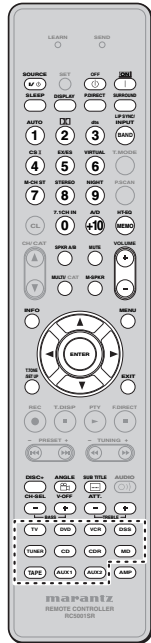

SOURCE ON / OFF	Turns the SR6001 on and off
POWER OFF	Turns the SR6001 off
POWER ON	Turns the SR6001 on
SLEEP	Sets the sleep timer function
DISPLAY	Changes the front display mode
P.DIRECT	Selects the pure direct mode
SURROUND	Selects the surround mode
AUTO (1)	Selects auto surround
DOLBY (2)	Selects DOLBY mode
mts (3)	Selects dts mode
CSII (4)	Selects CSII mode
EX/ES (5)	Selects EX/ES
VIRTUAL (6)	Selects VIRTUAL mode
M-CH ST (7)	Selects Multi Channel Stereo
STEREO (8)	Selects STEREO mode
NIGHT (9)	Turns on or off NIGHT mode
7.1CH IN (0)	Selects the 7.1CH IN
A/D (+10)	Switches between the analog or digital inputs
LIP SYNC / INPUT	Selects the LIP SYNC mode
HT-EQ	Turns on or off HT-EQ mode
SPKR A / B	Selects the speaker system
MULTI / CAT	Turns on or off multi room
MUTE	Decreases the sound temporarily
M-SPKR	Turns on or off multi speaker
VOLUME ▲ / ▼	Adjusts the over all sound level
INFO	Displays the current setting on the monitor
MENU	Enters the "SETUP MENU"
ENTER	Enters the "SETUP MENU"
	Confirms the setting in "SETUP MENU" mode
CURSOR	Moves the cursor for setting in "SETUP MENU" mode
T.TONE / SET UP	Enters the test tone menu
EXIT	Exits from SETUP MENU
CH-SEL	Calls up SETUP MENU and adjusts speaker levels or 7.1ch input level
V-OFF	Turns on or off video output
ATT.	Reduces the input level
BASS ▲ / ▼	Adjusts the tone control of low frequency sound
TREBLE ▲ / ▼	Adjusts the tone control of high frequency sound
SOURCE	Selects a particular source component

TUNER MODE

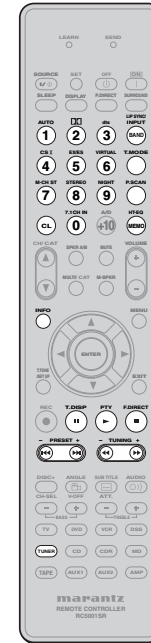

0-9	Inputs the numeric
BAND	Selects a radio band
T.MODE	Selects the auto stereo mode or mono mode
P.SCAN	Starts preset scan
CL	Clears the inputting
MEMO	Enters the tuner preset memory numbers
INFO	Shows preset information
T.DISP	Selects the display mode in RDS
PTY	Displays the programme type information of the current station
F.DIRECT	Selects the "Frequency direct input"
PRESET ▲ / ▼	Selects a preset station up and down
TUNING ▲ / ▼	Tunes a frequency station up and down

**CONTROLLING MARANTZ COMPONENTS**

1. Press the desired **SOURCE** button.
2. Press the desired operation buttons to play the selected component.
  - For details, refer to the component's user guide.
  - It may not be possible to operate some models.

**CONTROLLING A MARANTZ DVD PLAYER (DVD MODE)**

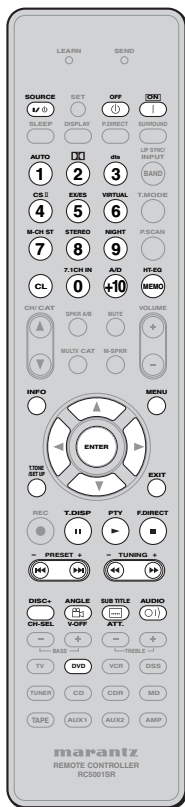

SOURCE ON / OFF	Turns the DVD player on and off
POWER OFF	Turns the DVD player off
POWER ON	Turns the DVD player on
0-9,+10	Inputs the numeric
CL	Clears the inputting
MEMO	Calls up programming menu
INFO	Displays the disc information
MENU	Calls up the menu of DVD disc
ENTER	Enters the setting
CURSOR	Moves the cursor for setting in "On Screen Display" mode
T.TONE / SET UP	Enters the test tone menu
EXIT	Exits from SETUP MENU
T.Tone/Set up	Calls up the setup menu of the DVD player
Pause	Pause
Play	Play
Stop	Stop
Previous/Next	Skips forward or previous chapter/track
Rewind/ Forward	Searchs forward or backward
DISC+	DVD changer next disc
ANGLE	Selects the camera angle
SUBTITLE	Selects the subtitle language
AUDIO	Selects the audio language

**CONTROLLING A MARANTZ CD (CD MODE)**

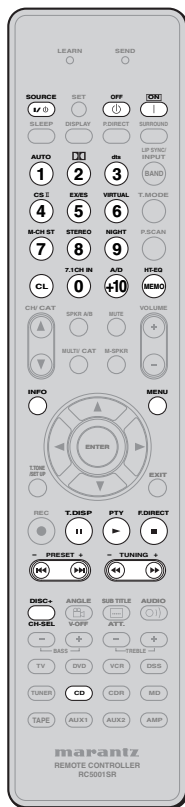

SOURCE ON / OFF	Turns the CD player on and off
POWER OFF	Turns the CD player off
POWER ON	Turns the CD player on
0-9	Inputs the numeric
CL	Clears the inputting
MEMO	Programs
INFO	Scrolls the disc information
MENU	Switches the display information
Pause	Pause
Play	Play
Stop	Stop
Previous/ Next	Skips forward or previous track
Rewind/ Forward	Searchs forward or backward
DISC+	CD changer next disc

**CONTROLLING A MARANTZ VCR (VCR MODE)**

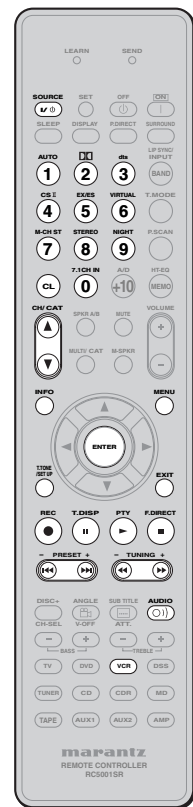

SOURCE ON / OFF	Turns the VCR on and off
0-9,+10	Inputs the numeric
LIP SYNC/INPUT	Selects TV/VCR
CL	Clears the inputting
MEMO	Calls up programming menu
CH ▲ / ▼	Selects VCR channel up or down
MENU	Calls up the menu
ENTER	Enters the setting
CURSOR	Moves the cursor for setting in "On Screen Display" mode
EXIT	Exits the programming menu
REC	Record
Pause	Pause
Play	Play
Stop	Stop
Previous / Next	Skips forward or previous track
Rewind / Forward	Searchs forward or backward
AUDIO	Selects the audio language

**CONTROLLING A MARANTZ CD RECORDER (CDR MODE)**

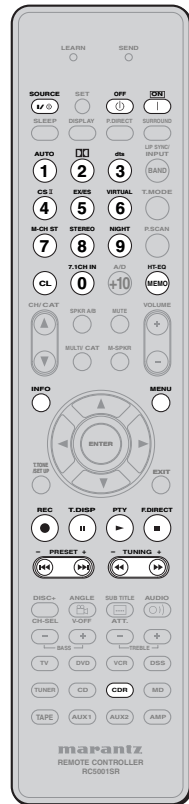

SOURCE ON / OFF	Turns the CD recorder on and off
POWER OFF	Turns the CD recorder off
POWER ON	Turns the CD recorder on
0-9	Inputs the numeric
CL	Clears the inputting
MEMO	Programs
INFO	Scrolls the disc information
MENU	Switches the display information
REC	Record
Pause	Pause
Play	Play
Stop	Stop
Previous / Next	Skips forward or previous track
Rewind / Forward	Searchs forward or backward

**CONTROLLING A MARANTZ MD DECK (MD MODE)**

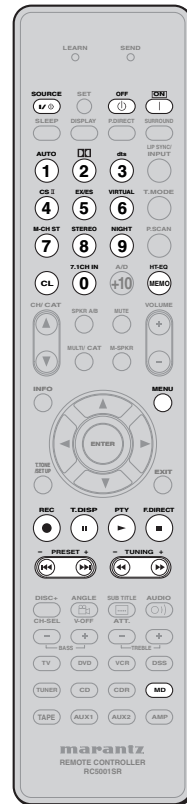

SOURCE ON / OFF	Turns the MD deck on and off
POWER OFF	Turns the MD deck off
POWER ON	Turns the MD deck on
0-9	Inputs the numeric
CL	Clears the inputting
MEMO	Programs
MENU	Switches the display information
REC	Record
Pause	Pause
Play	Play
Stop	Stop
Previous / Next	Skips forward or previous track
Rewind / Forward	Searchs forward or backward

**CONTROLLING A MARANTZ TAPE DECK (TAPE MODE)**

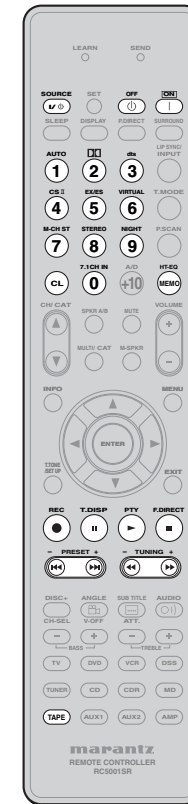

SOURCE ON / OFF	Turns the TAPE deck on and off
POWER OFF	Turns the TAPE deck off
POWER ON	Turns the TAPE deck on
0-9	Inputs the numeric
CL	Clears the inputting
MEMO	Programs
REC	Record
Pause	Pause
Play	Play
Stop	Stop
Previous / Next	Skips forward or previous track
Rewind / Forward	Searchs forward or backward

**BASIC OPERATION**

**NORMAL MODE**

*(When operating Marantz AV equipment products)*

This remote control is preset with a total of 12 types of remote codes, including Marantz TV (television), DVD, VCR (VCR deck), DSS (satellite broadcasting tuner), TUNER, CD, CD-R, MD, TAPE (tape deck), AUX1, AUX2, and AMP (amplifier).

Learning is not necessary for Marantz products. You can use these products without setting any codes.

1. Press the **SOURCE** button.  
For this example, press DVD.  
Pressing the **SOURCE** button once changes the remote control to the settings for the source that was pressed.  
To change the amplifier on other source, press the **SOURCE** button twice (double-click). The code is sent, and then the amplifier source changes to DVD.

**SETTING THE BACK LIGHT**

Each time press the buttons, illuminate button 2 seconds.  
To turn off back light, press and hold down the **SET** and **OFF** button until SEND indicator blinks twice.  
To turn on it again, press and hold down the **SET** and **ON** button until SEND indicator blinks twice.  
Initial is back light ON.

**PRESET MODE**

*(When operating non-Marantz AV equipment products)*

This remote control is preset with remote control codes from AV equipment by other manufacturers. The preset codes are TV, VCR, DVD and DSS. Settings can be made in one of two ways.  
When the preset codes are set, the following codes are contained in the source button of the remote control.

See the attached manufacturer number list for the preset manufacturers, devices, preset numbers, and other settings.

Remote control source name	Corresponding preset code	Device name
TV	TV	Television
DVD	DVD	DVD player
VCR	VCR	Video deck
DSS	SATELLITE	Satellite broadcasting tuner equipment

**Important:**

- Some codes may be not match your equipment. In this case, you can use LEARN mode to store these codes.
- The preset codes do not cover full functions. If you need extra function, use LEARN mode to store extra function.
- When the batteries are getting weak, the preset procedure is not successful.

**PROGRAMMING WITH THE 4-DIGIT CODE**

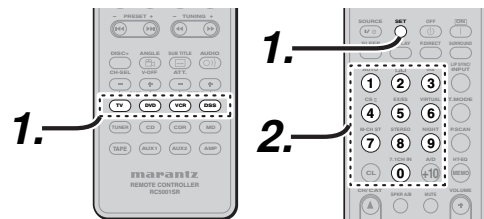

1. Press and hold down the **SOURCE** button for the appliance which should be controlled and press **SET** button until the SEND indicator blinks twice. Then back light flashes.
2. Press the 4-digit code for appliance (code table at the end of this book)  
When the procedure is successful, the SEND indicator will blink twice.

**Note:**

If the indicator did not blink twice, then repeat steps 1 through 2 and try entering the same code again.

**SCANNING THE CODE TABLE**

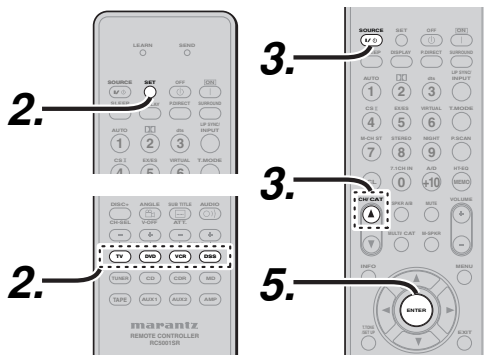

1. Switch on the appliance which should be controlled.

2. Press and hold down the **SOURCE** button for appliance which should be controlled and press **SET** button until the SEND indicator blinking twice. Then back light flashes.
3. Aim the remote control at the appliance and slowly alternate between pressing **CH+** button and the **SOURCE ON/OFF** button for the appliance.
4. Stop when the appliance turns off.
5. Press **ENTER** button once to lock in the code.

**CHECKING THE CODE**

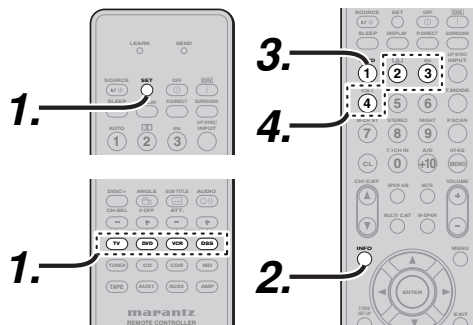

1. Press and hold down the **SOURCE** button for appliance which should be controlled and press **SET** button until the SEND indicator blinking twice then back light flashes.
  2. Press the **INFO** button.  
The SEND indicator will blink twice.
  3. To view the code for first digit, press **1** once.  
Wait 3 seconds, count the SEND indicator blinks (e.g. 3 blinks = 3) and write down the number.
- Note:**  
If a code digit is "0", the SEND indicator will not blink.
4. Repeat step **3** three more times for remaining digits. Use **2** for the second digit, **3** for the third digit, and **4** for the fourth digit.

**RESETTING THE CODE**

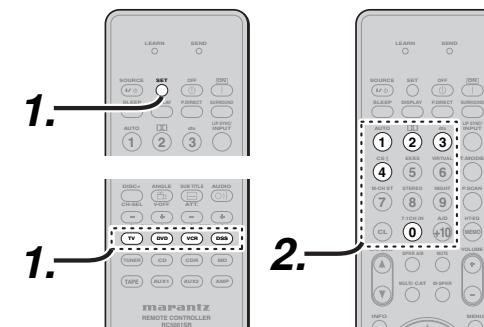

1. Press and hold down the **SOURCE** button for appliance which should be controlled and press **SET** button until the SEND indicator blinking twice. Then back light flashes.
2. Press the below codes to reset.  
TV : 1000  
DVD : 2000  
VCR : 3000  
DSS : 4000  
The indicator will blink twice.

**Note:**

After this procedure, the selected **SOURCE** button is set initial code.

**LEARN MODE**

This remote control is capable of learning and storing codes used by other remote controls that you already own.

For codes which are not learned, the remote control will transmit either the Marantz preset codes from the initial settings, or remote codes from another manufacturer's AV equipment which is set by the customer.

The receiver sensor for the remote control signals is located at the top of the remote control.

**Notes:**

- This remote control is capable to learn around 60 codes.
- When the batteries are getting weak, the learning procedure is not successful.

**LEARNING PROCEDURE**

1. Place the remote controller so that its infrared signal transmitter is facing the infrared signal receiver on the Marantz remote controller at a distance of about 0.05 m (2 inches).

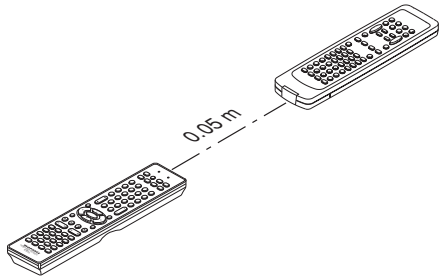

2. Press and hold down the **SET** and **MENU** buttons until LEARN indicator blinks.

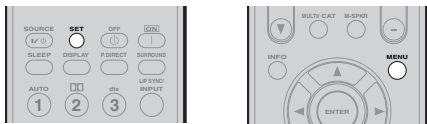

3. Select the **SOURCE** button to select the SOURCE.

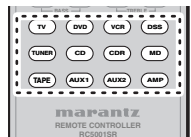

4. Select the button to be learned.

- LEARN indicator lights up.

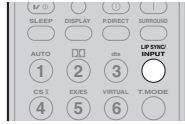

5. Press and hold the button of the original remote controller to learn until the SEND indicator blinks twice.

- When the SEND indicator blinks once, repeat this step.
- When the memory of the RC5001SR is full, the LEARN and SEND indicators blink once. If you want to learn the code, you should erase other learned button.

6. Repeat steps 4 and 5 to learn other buttons in same SOURCE.

7. Repeat steps 3 to 6 to learn other SOURCE.

8. When you have finished programming the remote controller, press the **SET** button, then LEARN indicator stops blinking and exits from the LEARN mode.

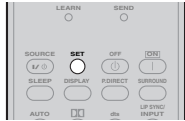

**Notes:**

- When the SEND indicator blinks once again, the transmitting code is unavailable for RC5001SR, or the transmitting signal is intercepted by noise.
- If no buttons are pressed for approximately 1 minutes while in the LEARN mode, the remote controller automatically exits from the LEARN mode.

**ERASING PROGRAMMED CODES (RETURNING TO INITIAL SETTINGS)**

Codes can be erased in three ways: by buttons, sources, and by all memory contents.

**Erasing the code by buttons**

1. Press and hold down the **SET** and **MENU** buttons until LEARN indicator blinks.

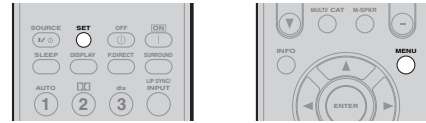

2. Select the **SOURCE** button to select the button to be erased.

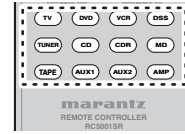

3. Press and hold down the **SLEEP** button and press the learned button twice to be erased.

- SEND indicator blinks twice and the mode returns to LEARN mode.

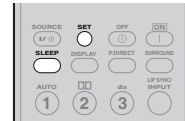

4. To return the NORMAL mode, press the **SET** button.

**Erasing the code by SOURCE**

1. Press and hold down the **SET** and **MENU** buttons until LEARN indicator blinks.

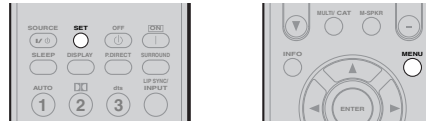

2. Press and hold down the **SLEEP** button and press the learned **SOURCE** button twice to be erased.

- LEARN indicator lights.

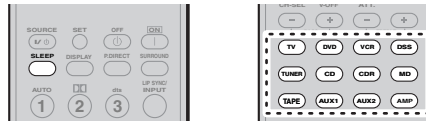

3. Press **ENTER** button to continue erasing.

- The SEND indicator blinks twice and the mode returns to LEARN mode.
- To cancel the erasing operation, do not press **ENTER** button and simply touch any other button.

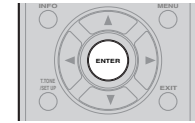

4. To return the NORMAL mode, press the **SET** button.

**Erasing the all SOURCES**

1. Press and hold down the **SET** and **MENU** buttons until LEARN indicator blinks.

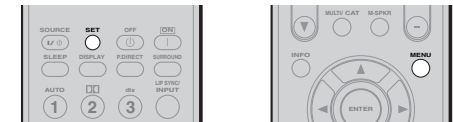

2. Press and hold down the **SLEEP** button and press **POWER ON** and **POWER OFF** button.

- LEARN indicator lights.

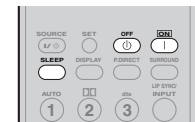

3. Press **ENTER** button to continue erasing.

- The SEND indicator blinks twice and the mode returns to LEARN mode.
- To cancel the erasing operation, do not press **ENTER** button and simply touch any other button.

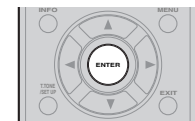

4. To return the NORMAL mode, press the **SET** button.

**Note:**

Erasing codes will return to the factory preset code, or there will leave empty if the button has no factory preset code.



# CONNECTIONS

## SPEAKER PLACEMENT

The ideal surround speaker system for this unit is 7-speaker systems, using front left and right speakers, a center speaker, surround left and right speakers, a surround back left and right speakers, and a subwoofer.

For best results we recommend that all front speakers be of the same type, with identical or similar driver units. This will deliver smooth pans across the front sound stage as the action moves from side to side. Your center channel speaker is very important as over 80 % of the dialog from a typical motion picture emanates from the center channel.

It should possess similar sonic characteristics to the main speakers. Surround channel speakers need not be identical to the front channel speakers, but they should be of high quality.

The surround center speaker is useful for playback of Dolby Digital Surround EX or DTS-ES. One of the benefits of both Dolby Digital and DTS is that surround channels are discrete full range, while they were frequency limited in earlier "Pro Logic" type systems.

Bass effects are an important part of home theater. For optimal enjoyment a subwoofer should be used as it is optimized for low frequency reproduction. If you have full range front speakers, however, they may be used in place of a subwoofer with proper setting of the switches in the menu system.

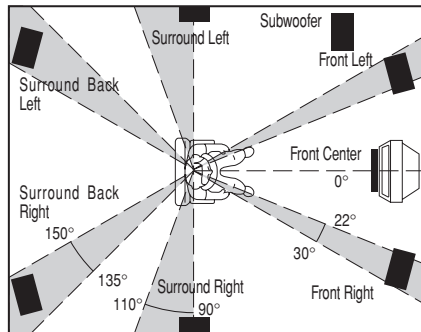

### Front left and right speakers

We recommend to set the front L and R speakers with 45-60 degrees from the listening position.

### Center speaker

Align the front line of the center speaker with the front L/R speakers. Or place the center speaker a little backward from the line.

### Surround left and right speakers

When the SR6001 is used in surround operation, the preferred location for surround speakers is on the side walls of the room, at or slightly behind the listening position.

The center of the speaker should face into the room.

### Surround back left and right speakers

Surround back speakers are required when a full 7.1-channel system is installed.

Speakers should be placed on a rear wall, behind the listening position.

The center of the speaker should face into the room.

### Subwoofer

We recommend using a sub-woofer to have maximum bass effect. Sub-woofer bears only low frequency range so you can place it any where in the room.

## HEIGHT OF THE SPEAKER UNITS

### Front left and right speakers, and a center speaker

Align the tweeters and mid-range drivers on the three front speakers at the same height, as best as possible.

### Surround left and right speakers, and surround back speaker

Place the surround left, right and surround back speakers higher than your ears by about 70cm-1m. Also place the speakers at the same height, as best as possible.

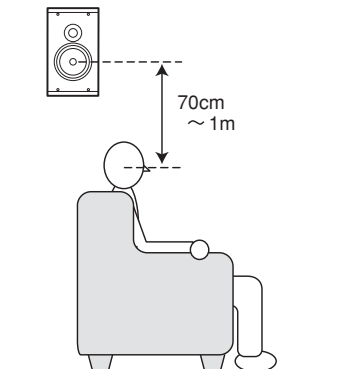

### Note:

- Use magnetically-shielded speakers for front left, right and the center speakers when the speakers are installed near the TV and the TV is a monitor type.

## CONNECTING SPEAKERS

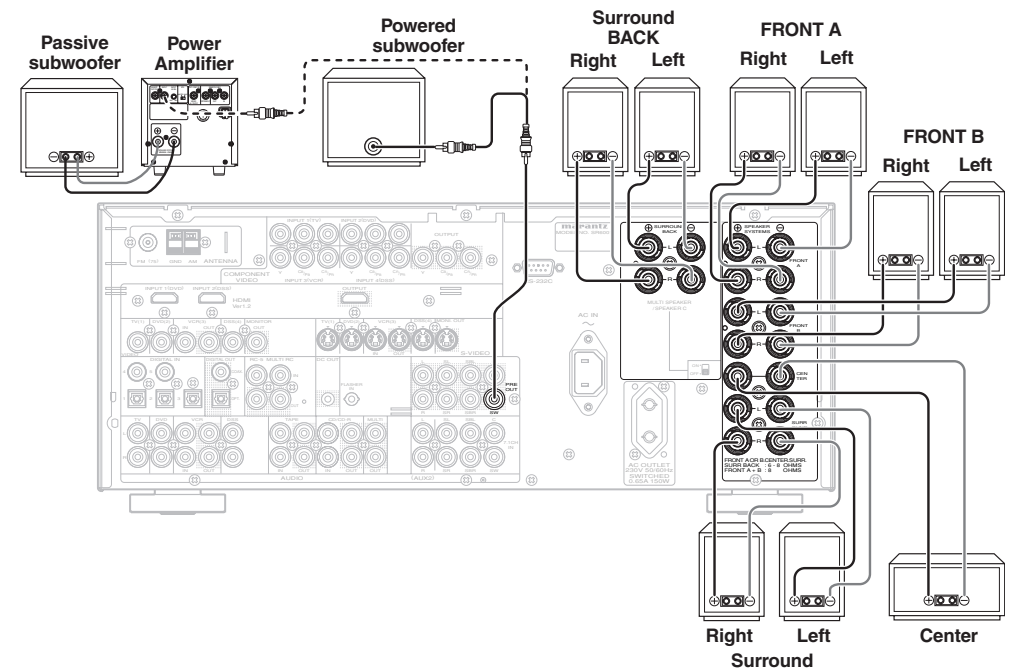

## CONNECTING SPEAKER WIRE

1. Strip away approx. 3/8 inch (10 mm) of wire insulation.
2. Twist the bared wire ends tight, to prevent short circuits.
3. Loosen the knob by turning it counterclockwise.
4. Insert the bare part of the wire into the hole in side of each terminal.
5. Tighten the knob by turning it clockwise to secure the wire.

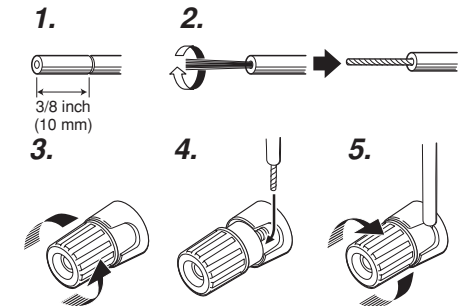

**Caution:**

- Be sure to use speakers with the specified impedance as shown on the rear panel of this unit.
- To prevent damage to circuitry, do not let the bare speaker wires touch each other and do not let them touch any metal part of this unit.
- Do not touch the speaker terminals when the power is on. It may cause you to receive an electric shocks.
- Do not connect more than one speaker cable to one speaker terminal. Doing so may damage this unit.

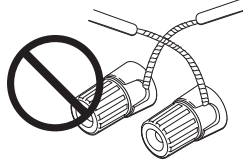

**Note:**

- Be sure to connect the positive and negative cables for the speaker properly. If they are miss-connected, the signal phase will be reversed and the signal quality will be corrupted.

**CONNECTING A SUBWOOFER**

Use the PRE OUT SUBWOOFER jack to connect a powered subwoofer (power amplifier built in ). If your subwoofer is a passive type (power amplifier is not built in), connect a monaural power amplifier to the PRE OUT SUBWOOFER jack and connect the subwoofer to the amplifier.

**CONNECTING AUDIO COMPONENTS**

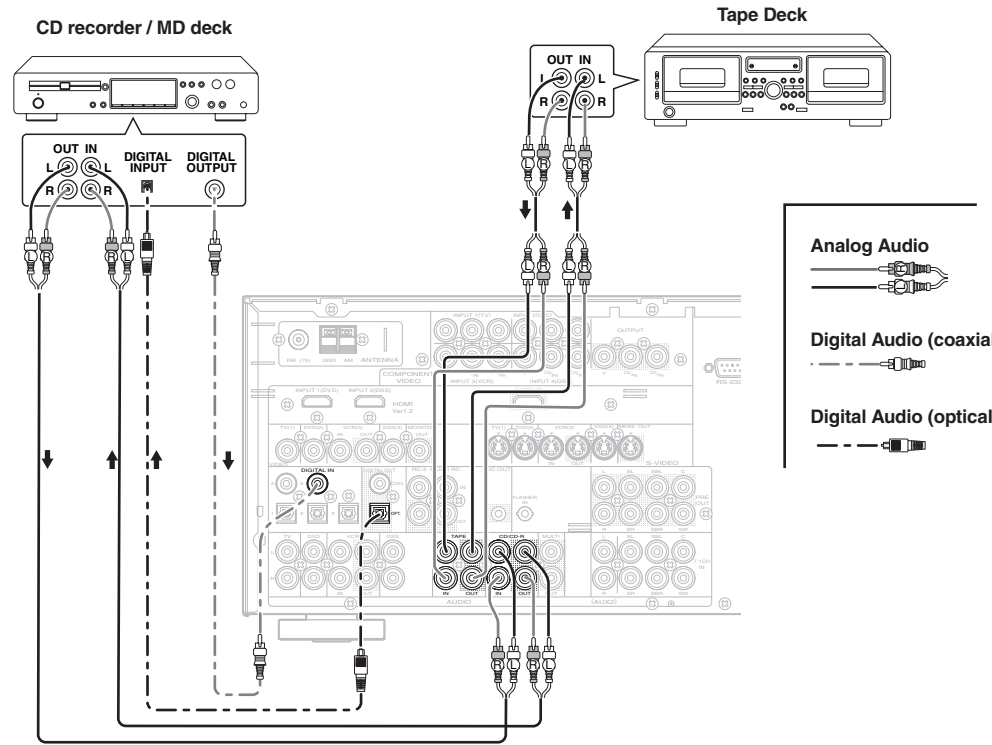

The output audio signal from the TAPE OUT jack and the CD/CD RECORDER OUT jack is the same signal which is currently selected.

**Caution:**

- Do not connect this unit and other components to mains power until all connections between components have been completed.

**Notes:**

- Insert all plugs and connectors securely. Incomplete connections may make noise.
- Be sure to connect the left and right channels properly.  
Red connectors are for the R (right) channel, and white connectors are for the L (left) channel.
- Be sure to connect input and output properly.
- Refer to the instructions for each component that is connected to this unit.
- Do not bind audio/video connection cables with power cords and speaker cables this will result in generating a hum or other noise.

**CONNECTING DIGITAL AUDIO COMPONENTS**

- There are 5 digital inputs, 2 coaxial jacks and 3 optical jacks, on the rear panel. You can use these jacks to input PCM, Dolby Digital and DTS bitstream signals from a CD, DVD, or other digital source components.
- There is one digital output coaxial jack and one optical output jack on the rear panel. These jacks can be connected to a CD recorder, or a MD deck inputs, respectively.
- Refer to the instructions for each component. To setup the digital audio format of DVD player, or other digital source's connected to digital input jacks.
- Use fiber optical cables (optical) for DIG-1,2,3 input jacks. Use 75 ohms coaxial cables (for digital audio or video) for DIG-4, 5 input jacks.
- You can designate the input for each digital input/output jacks according to your component. See page 28.

**Notes:**

- There is no Dolby Digital RF input jack. Use an external RF demodulator Dolby Digital decoder when connecting the Dolby Digital RF output jack of the videodisc player to the digital input jack.
- The digital signal jacks on the SR6001 conform to the EIA standard. If you use a cable that does not conform to this standard, the SR6001 may not function properly.
- Each type of audio jack works independently. Signals input through the digital and analog jacks are output through the corresponding digital and analog jacks, respectively.

## HDMI JACK

This SR6001 has two HDMI inputs and one HDMI output. The unit can send digital video and audio signals from DVDs and other sources directly to a display. It minimizes signal degradation caused by analog conversion so that high quality images can be enjoyed.

The SR6001 is also capable of converting analog video signals (Composite Video, S-Video, Component Video) for HDMI output.

Select an input source from the OSD menu system. (See page 28, 39)

### Notes:

- When the HDMI output is connected to a display monitor that does not support HDCP, signals are not output. To view images in HDMI, it is necessary to connect to a display that supports HDCP.
- There may be no image output if connected to a TV or display that is not compatible with the above format.
- Refer to the instruction manual of the TV or display to be connected to the SR6001 for detailed information regarding the HDMI terminal.

\* **HDCP: High-bandwidth Digital Content Protection**

## CONNECTING HDMI DEVICES

An HDMI cable (sold separately) is used to connect the HDMI jack on the SR6001 with the HDMI jack on a DVD player, TV, projector or other component. To transmit multichannel audio via HDMI, the connected player must support multichannel audio transmission through its HDMI jack.

HDMI video streaming is compatible with DVI in principle. Therefore, it is possible to connect to a TV or monitor that has a DVI terminal using an HDMI-DVI conversion cable or plug. When connecting to a DVI terminal, connect the audio signal separately.

### Notes:

- Some HDMI components can be controlled over the HDMI cable, but this receiver cannot control other components this way.
- When connected to a monitor (i.e., TV, projector, etc.) that does not support HDCP, video and audio are not output.
- DVI cables come with 24-pin and 29-pin plugs. This receiver supports 24-pin DVI-D cables; 29-pin DVI cables cannot connect to it.
- Some source devices such as DVD players or set top box do not support HDMI repeater operations like those of the SR6001. In such case, pictures are not properly projected on monitors such as TVs and projectors.

- When multiple components are connected to this receiver, turn power to unused components off to prevent interference between them.
- Disconnecting or connecting cables with the power on can damage the equipment. Turn the power off before disconnecting or connecting cables.
- Some DVD-Audio disks disable downmixing. These types of disks are not played back correctly unless the left, center, right and surround left and right speakers, and subwoofer are connected.
- If a DVD player that does not support HDMI 1.1 is connected to the SR6001, multi channel PCM playback is not possible even with DVD-Audio disks.
- If an Super Audio CD player that does not support HDMI 1.2 is connected to the receiver, DSD playback is not possible even with Super Audio CD.  
(\*DSD: Direct Stream Digital)
- If a DVD player or other device with DVI output is connected to the SR6001, a separate audio cable (optical-digital, coaxial digital or analog) is needed for the audio signals. In this case, select the connected audio input as explained in "1-1 FUNC INPUT SETUP". (See page 28)
- Multi channel PCM signals and audio signals of 62 kHz or higher that are input from the HDMI jack are not output from the DIGITAL OUT jacks.
- Depending on the quality of the cable used, the HDMI signal may be affected by noise.

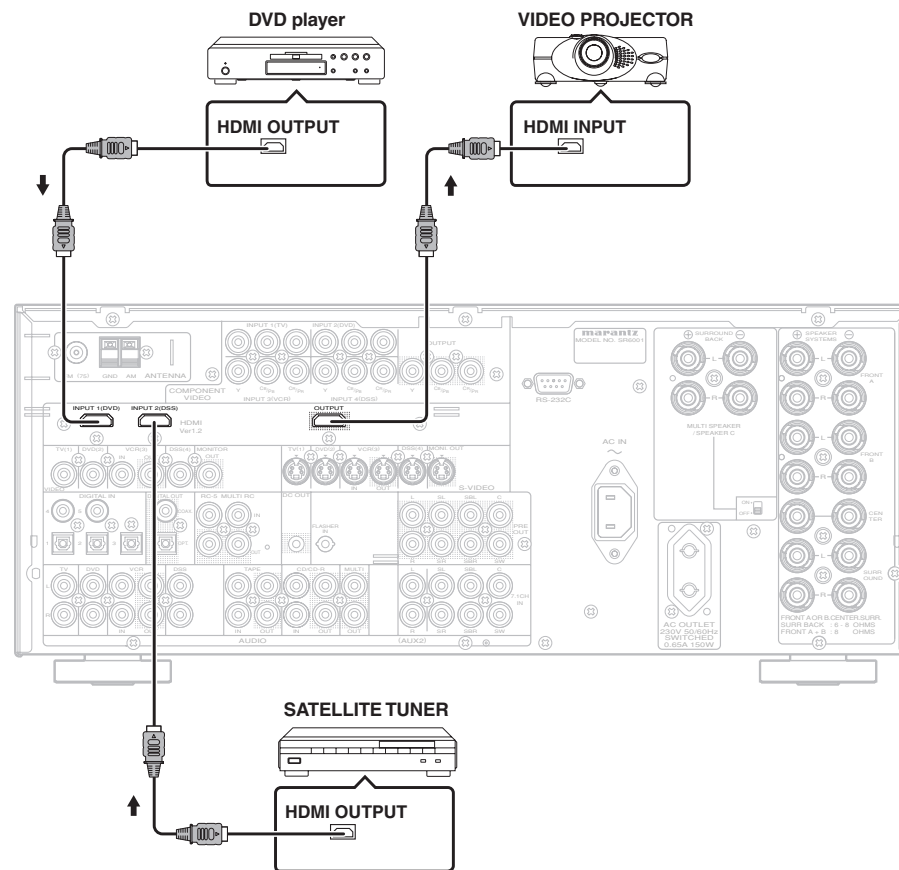

CONNECTING VIDEO COMPONENTS

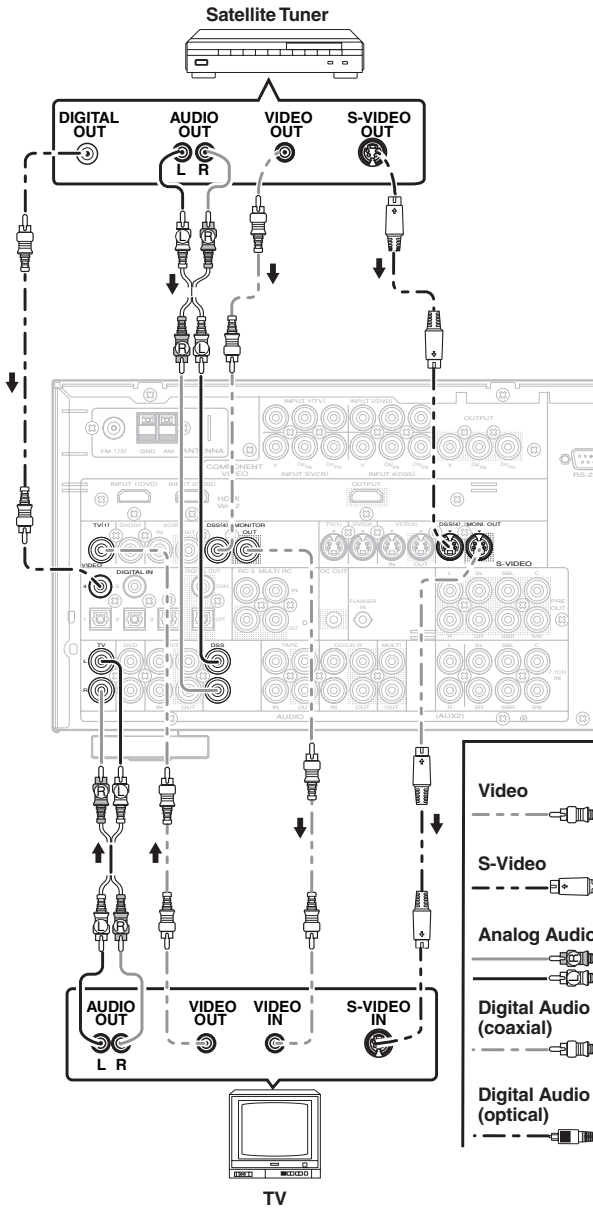
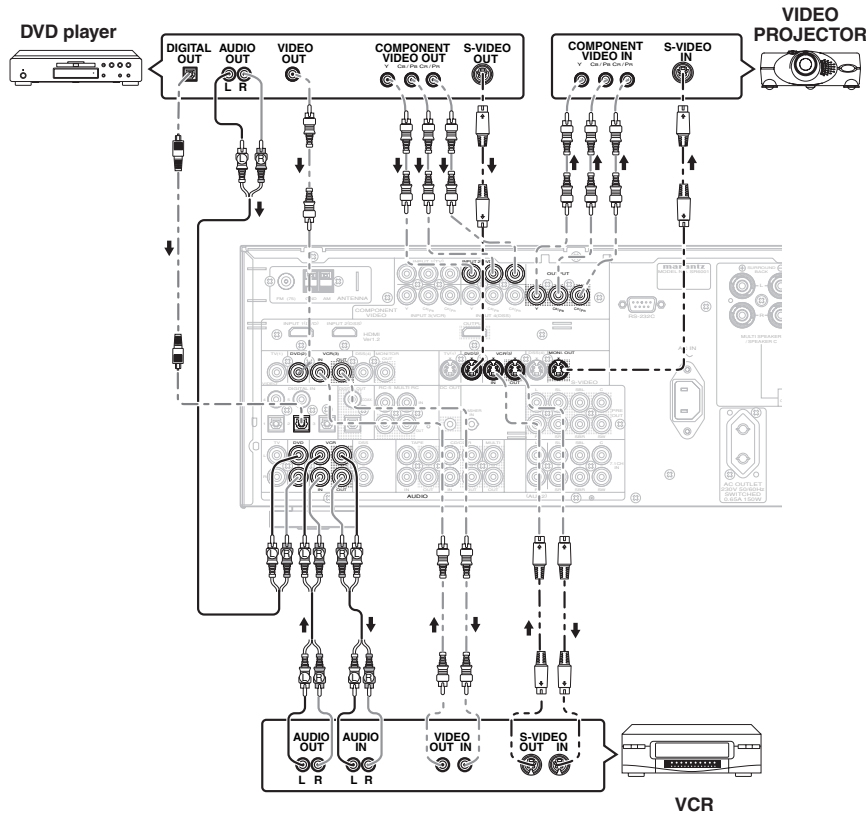

VIDEO, S-VIDEO, COMPONENT JACKS

There are 3 types of video jacks on the rear panel.

**VIDEO jack**

The video signal for the VIDEO jacks is the conventional composite video signal.

**S-VIDEO jack**

The video signal is separated into luminance (Y) and color (C) signals for the S-VIDEO jack. The S-VIDEO signals enables high-quality color reproduction. If your video component has an S-VIDEO output, we recommend to use it. Connect the S-VIDEO output jack on your video component to the S-VIDEO input jack on the SR6001.

**Component jack**

Make component video connections to a TV or monitor with component inputs to produce higher quality video images. Use a component video cable or 3 video cords to connect the component video out jacks on the SR6001 to the monitor.

**Notes:**

- Be sure to connect the left and right audio channels properly. Red connectors are for the R (right) channel, and white connectors are for L (left) channel.
- Be sure to connect the inputs and outputs of the video signals properly.
- If you connect the S-VIDEO or component signal to the S-VIDEO or component jack on the SR6001, it is not necessary to connect the conventional video signal to the VIDEO (composite) jack. If you use both video inputs, the SR6001 gives priority to the S-VIDEO signal.
- Each type of video jack works independently. Signals input to the VIDEO (composite) and S-VIDEO jacks or component are output to the corresponding VIDEO (composite) and S-VIDEO or component jacks, respectively.
- The SR6001 has the "TV-AUTO ON/OFF" function to turn the TV ON or OFF automatically, by sensing the incoming video signal from the VIDEO jacks.
- You may need to setup the digital audio output format of your DVD player, or other digital source components. Refer to the instructions of the each component connected to the digital input jacks.
- There is no Dolby Digital RF input jack. Use an external RF demodulator Dolby Digital decoder when connecting the Dolby Digital RF output jack of the videodisc player to the digital input jack.



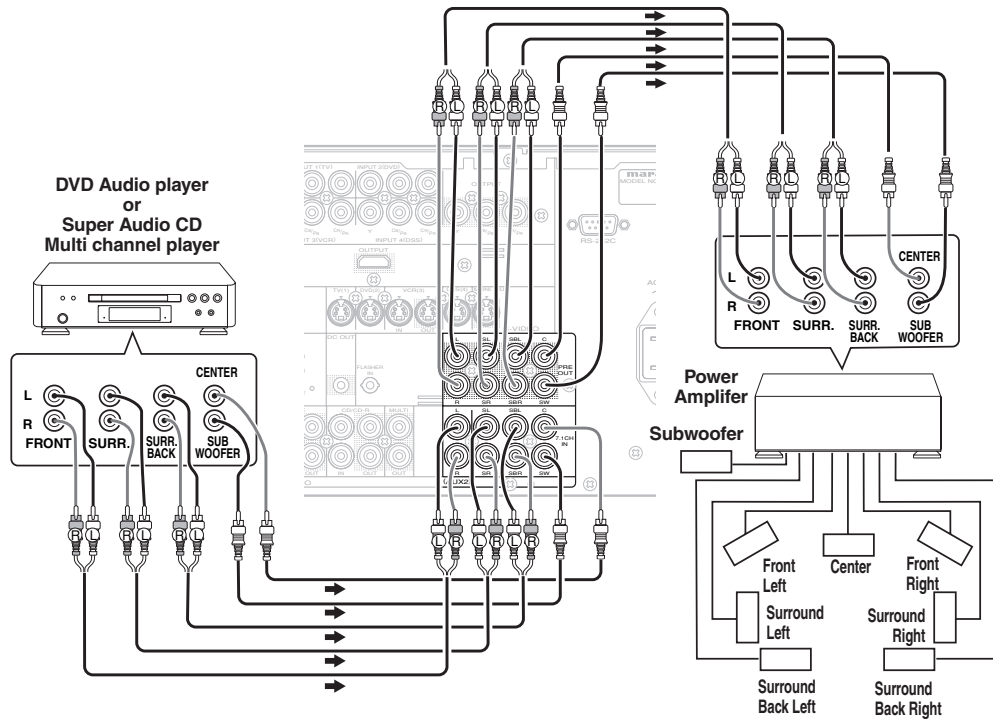

**CONNECTING MULTI CHANNEL AUDIO SOURCE**

The 7.1CH INPUT jacks are for multichannel audio source such as a Super Audio CD multichannel player, DVD audio player or external decoder. If you use these jacks, switch on the 7.1CH INPUT and set the 7.1CH INPUT level by using the SETUP MAIN MENU. See page28.

**CONNECTING AN EXTERNAL POWER AMPLIFIER**

The PREOUT jacks are for connecting external power amplifiers. Be sure to connect each speaker to the corresponding external power amplifier.

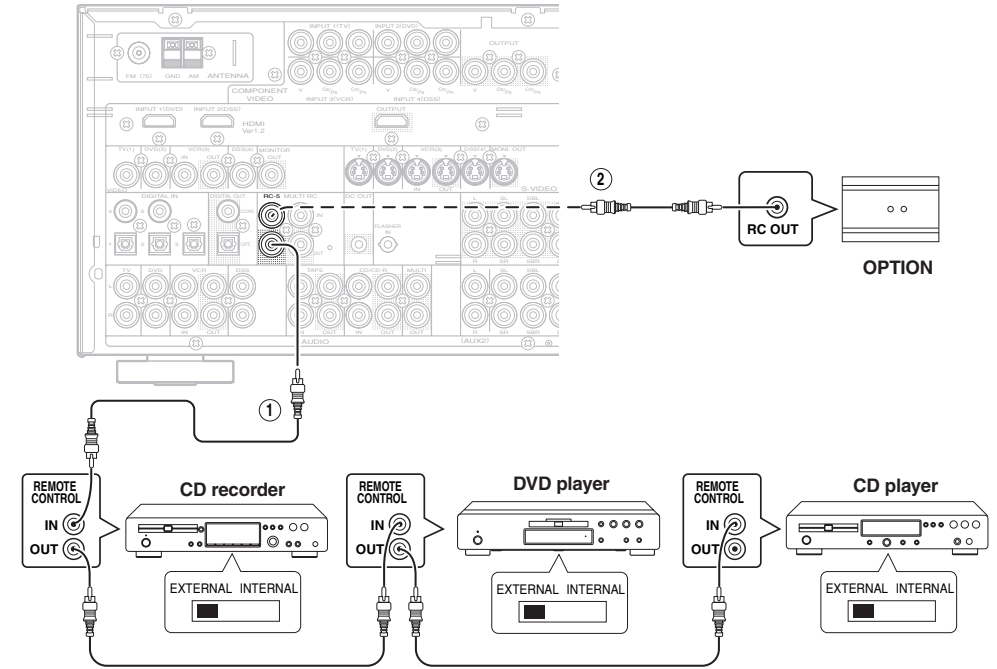

①

You can control other Marantz products through the SR6001 with the remote control by connecting the REMOTE CONTROL terminals on each unit. The signal transmitted from the remote control is received by the remote sensor on the SR6001. Then the signal is sent to the connected device through this terminal. Therefore you need to aim the remote control only at the SR6001. Also, if a Marantz power amplifier (some models excluded) is connected to one of these terminals, the power amplifier's power switch is synchronized with this unit's power switch.

Set the REMOTE CONTROL SWITCH on the other units, (not the SR6001) to "EXT." (external) to use this feature.

②

Whenever external infrared sensors or similar devices are connected to RC-5 IN of the SR6001, be sure to always disable operation of the infrared sensor on the main unit by using the following procedure.

1. Hold down the **MULTI** button and the **MENU** button on the front panel at the same time for five seconds.
2. The setting "IR=ENABLE" is shown on the FL DISPLAY.
3. Press the **CURSOR** buttons (◀, ▶) to change this to "IR=DISABLE".
4. Press the **ENTER** button. Once this setting is made, the infrared sensor on the main unit is disabled.

**Note:**

- Be sure to set to "IR=ENABLE" when external infrared sensors or similar devices are not connected. Otherwise, the main unit will be unable to receive remote control commands.
5. To restore the original setting, perform steps 1 to 4 to set to "IR=ENABLE".

**CONNECTING THE ANTENNA TERMINALS**

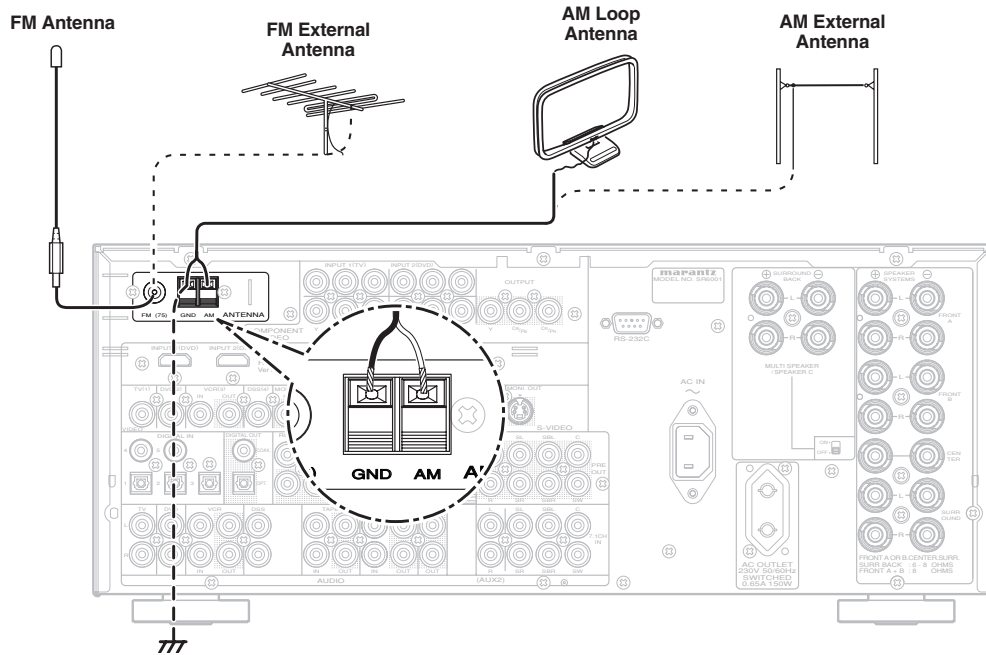

**ASSEMBLING THE AM LOOP ANTENNA**

1. Release the vinyl tie and take out the connection line.
2. Bend the base part in the reverse direction.
3. Insert the hook at the bottom of the loop part into the slot at the base part.
4. Place the antenna on stable surface.

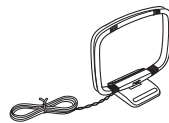
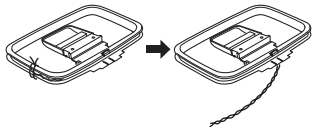

2. Bend the base part in the reverse direction.



3. Insert the hook at the bottom of the loop part into the slot at the base part.

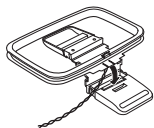

**CONNECTING THE SUPPLIED ANTENNAS**

**Connecting the supplied FM antenna**

The supplied FM antenna is for indoor use only. During use, extend the antenna and move it in various directions until the clearest signal is received. Fix it with push pins or similar implements in the position that will cause the least amount of distortion. If you experience poor reception quality, an outdoor antenna may improve the quality.

**Connecting the supplied AM loop antenna**

The supplied AM loop antenna is for indoor use only. Set it in the direction and position it to where you receive the clearest sound. Put it as far away as possible from the unit, televisions, speaker cables, and power cords. If you experience poor reception quality, an outdoor antenna may improve the quality.

1. Press and hold down the lever of the AM antenna terminal.
2. Insert the bare wire into the antenna terminal.
3. Release the lever.

**Note:**

- Connect the shielded grounding wire (black) to the AM antenna GND terminal.

**CONNECTING AN FM OUTDOOR ANTENNA**

**Notes:**

- Keep the antenna away from noise sources (neon signs, busy roads, etc.).
- Do not put the antenna close to power lines. Keep it well away from power lines, transformers, etc.
- To avoid the risk of lightning and electrical shock, grounding is necessary.

**CONNECTING AN AM OUTDOOR ANTENNA**

An outdoor antenna will be more effective if it is stretched horizontally above a window or outside.

**Notes:**

- Do not remove the AM loop antenna.
- To avoid the risk of lightning and electrical shock, grounding is necessary.



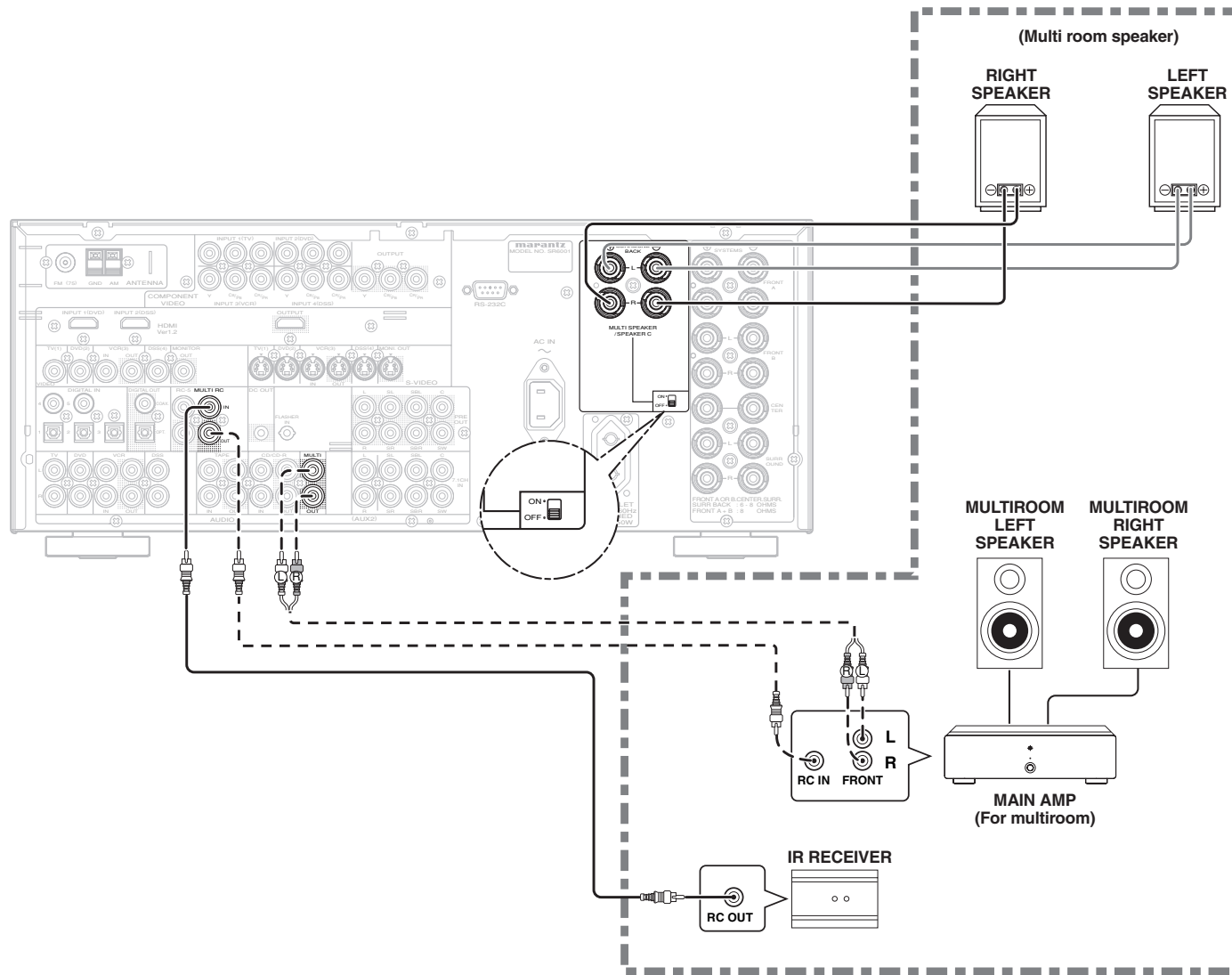

**Bi-wire Connection**

A bi-wire connection is possible with speakers that have two sets of inputs (for treble and bass). This allows you to drive the treble and bass units with separate channel amps, which enables better sound quality. Connect the speakers as shown in the figure. Set the SPEAKER C selector switch on the rear panel to ON.

**Notes:**

- If incorrectly connected, a protective circuit in the receiver will trip and set the receiver to standby. (The STANDBY indicator will flash.) In such case, recheck the connections between the speakers and the receiver.
- Turn power to the receiver off before changing the setting of the SPEAKER C selector switch.
- If the speaker is fitted with a shorting bar, remove the shorting bar.

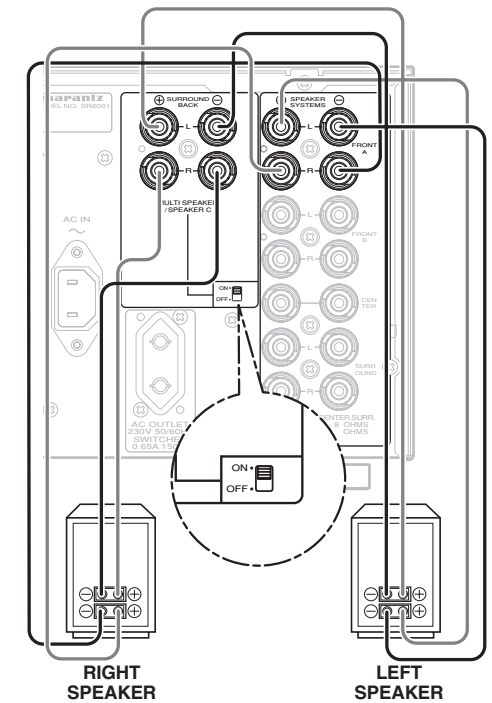

**Note:**

- You can use surround back speaker terminals as MULTI SPK. terminals or SPEAKER C terminal when you are not using surround back speakers.

## CONNECTING OTHER EQUIPMENT

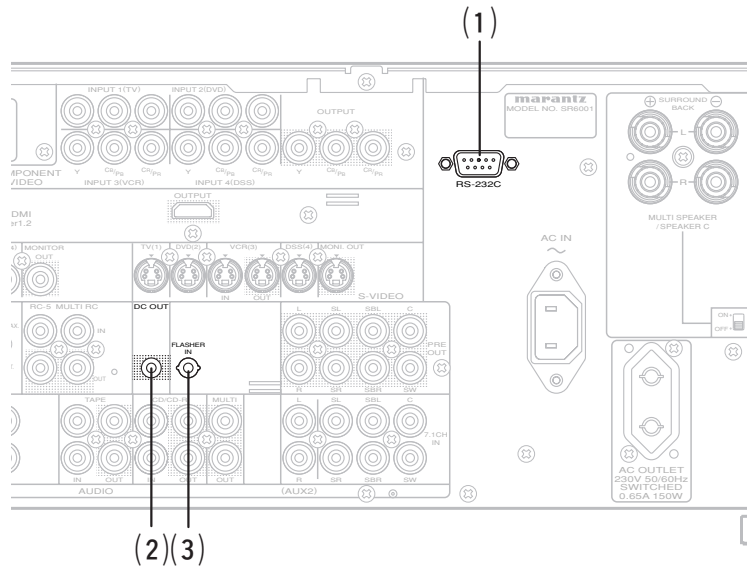
**(1) RS232C**

Connect an external control device or other device for servicing. (Use a straight cable for the connection.)

**(2) DC OUT (DC TRIGGER)**

External devices can be controlled from the SR6001 by connecting them to the DC OUT terminal (12 V).

**(3) FLASHER IN**

This receiver can be controlled by connecting a control box or other control device to this receiver.

# SETUP

After all components are connected, initial setup must be performed.

## ONSCREEN DISPLAY MENU SYSTEM

The SR6001 incorporates an onscreen menu system, which makes various operations possible by using the cursor (▲, ▼, ◀, ▶) and **ENTER** buttons on the remote control unit or on the front panel.

**Note:**

- To view the onscreen displays, make certain you have connected the MONITOR OUT jack on the rear panel to the composite, S-Video, component video or HDMI input of your TV or projector. (See page 19, 20)

1. Press the **AMP** button on the remote control unit. (This step is not needed when operating the setup menus from the SR6001.)
2. Press the **MENU** button on the remote control or press the **MENU** button on the front panel. The "MAIN MENU" of the OSD menu system is displayed. There are 6 items in the MAIN MENU.
3. Select the desired sub-menu with the ▲ or ▼ cursor buttons and press the **ENTER** button. The display will change to the selected sub-menu.

**Notes:**

- If you desire to adjust any sub-menu, you need to set it to **UNLOCKED**.
- To lock sub-menus, set items 1-6 on the MAIN MENU to "LOCKED".

**<LOCKING SUBMENUS>**

- (1) Move the cursor to "1. INPUT SETUP" in the MAIN MENU.
  - (2) Select the "●" mark left of "LOCKED" with the ◀ or ▶ cursor buttons.
4. To exit from OSD menu system, press the **EXIT** button, or move the cursor to **EXIT** and press the **ENTER** button.

**Note:**

- Settings are entered with the **ENTER** button on the unit or the remote control unit.

## RC5001SR BUTTON CONTROL

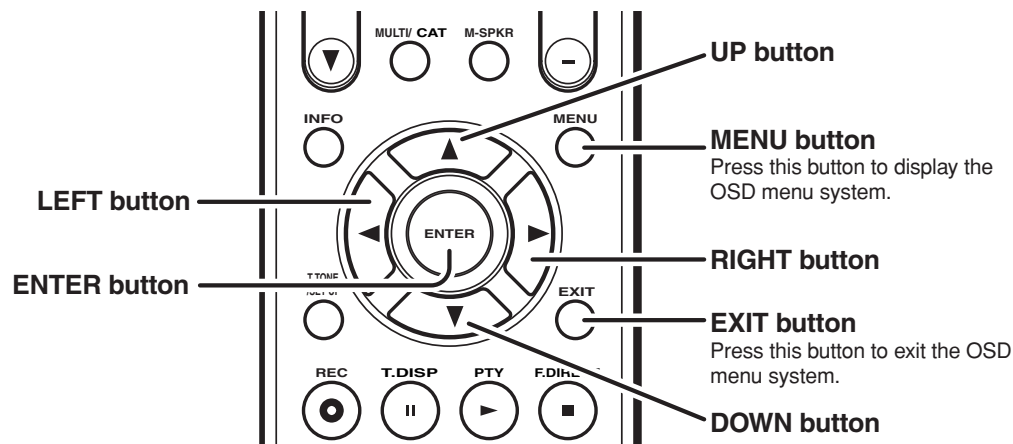

## SR6001 FRONT BUTTON CONTROL

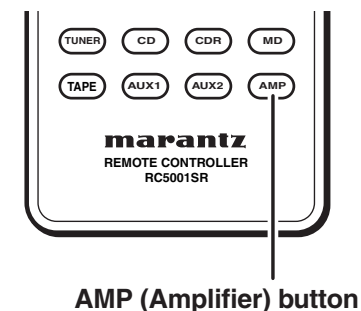
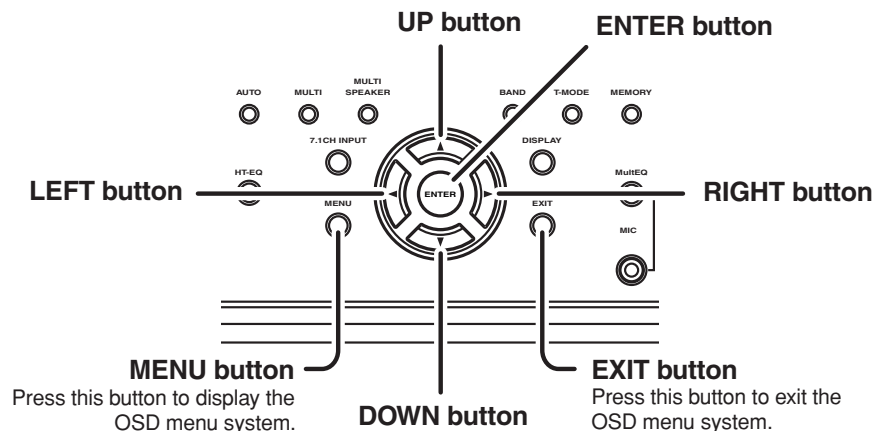

AMP (Amplifier) button

**Note:**

- After you complete this portion of the setup, move cursor to "RETURN" with the ▲, ▼, ◀ and ▶ cursor buttons and press the ENTER button.

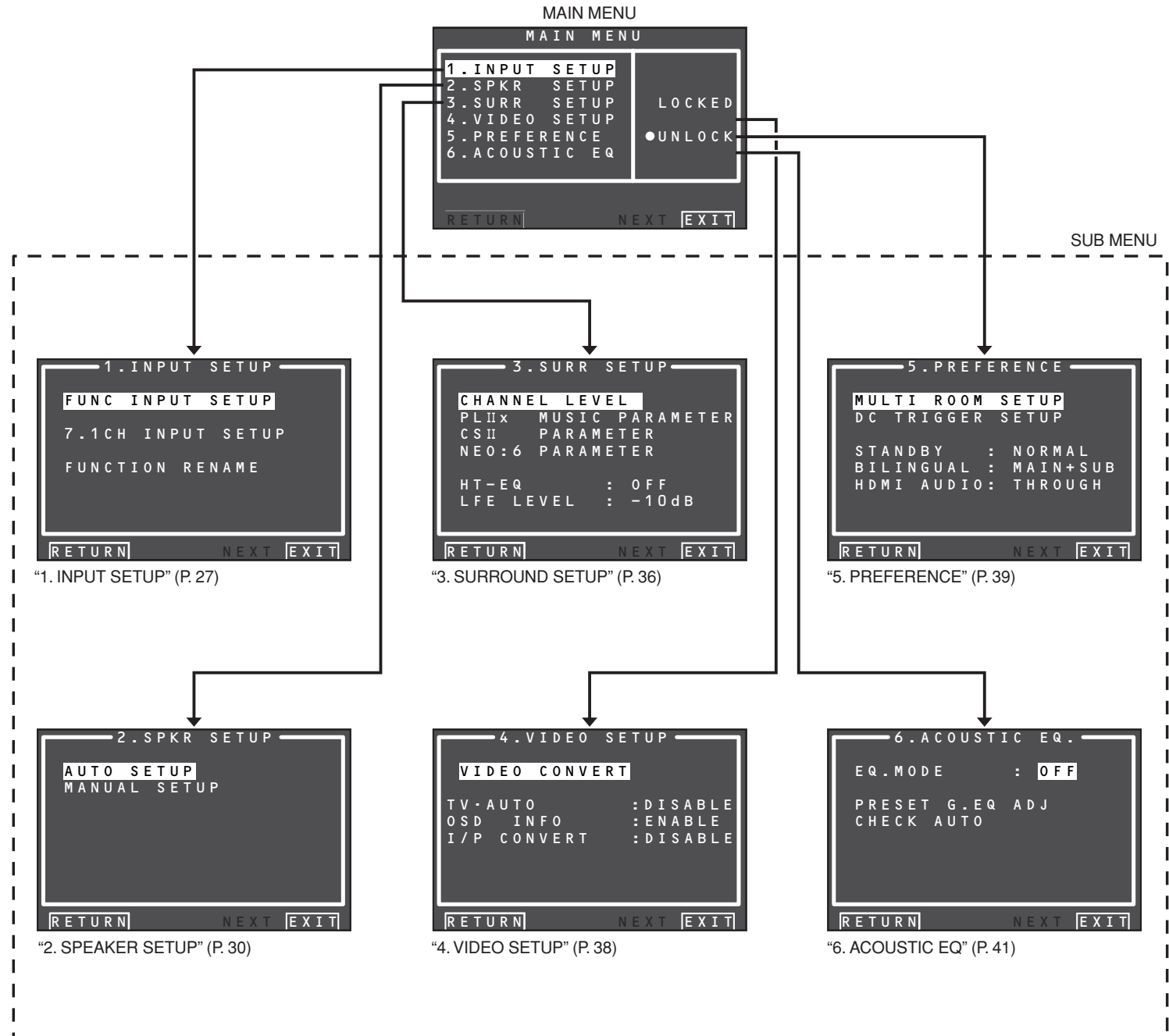

# 1 INPUT SETUP

This menu is for setting the matching the output of connected audio devices and the input jacks of this receiver.

- **FUNC INPUT SETUP :**  
"1-1 FUNC INPUT SETUP" (see page 28)
- **7.1 CH INPUT SETUP :**  
"1-2 7.1 CH INPUT SETUP" (see page 28)
- **FUNC RENAME :**  
"1-3 FUNCTION RENAME" (see page 29)

1. Select "1. INPUT SETUP" from the MAIN MENU with ▲ or ▼ cursor button, and press the ENTER button.

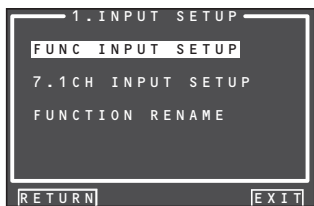

2. Select the desired sub-menu with the ▲ or ▼ cursor buttons, and press the ENTER button.

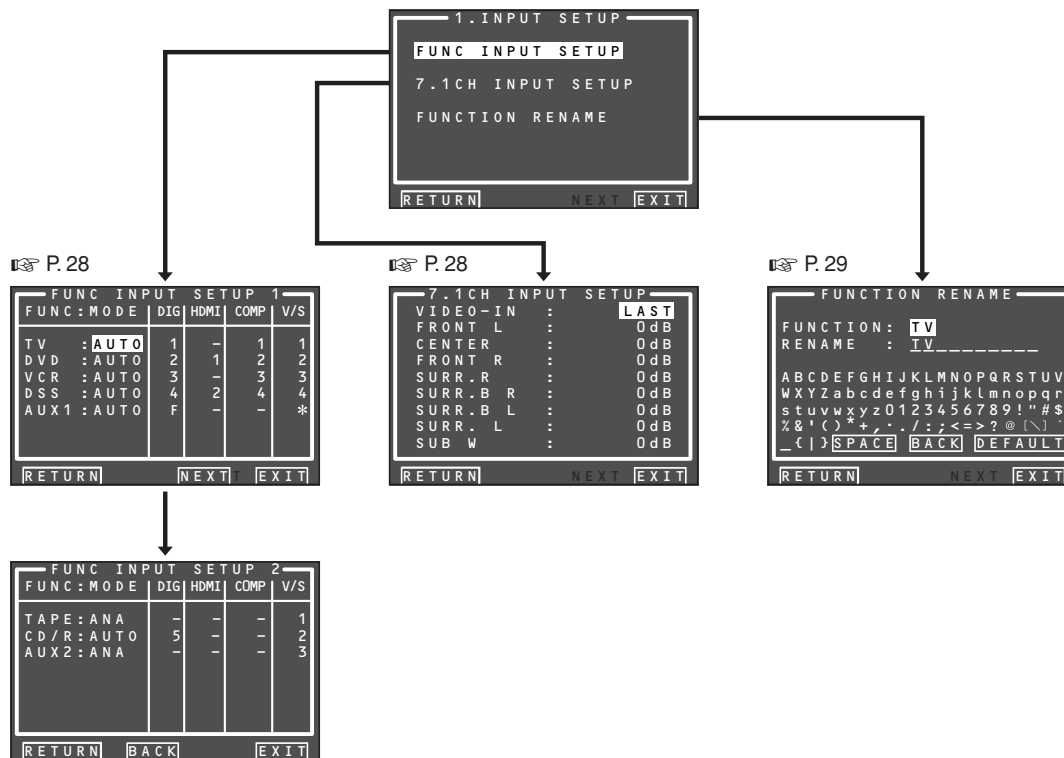



## 1-1 FUNC INPUT SETUP (ASSIGNABLE DIGITAL INPUT)

The 5 and F (Front) digital inputs can be assigned to a desired source.

HDMI and COMPONENT inputs can be assigned to the preferred source.

Use this menu to select which digital input jacks are to be assigned to which input source.

1. Select "**FUNC INPUT SETUP**" from the 1.INPUT SETUP menu with the ▲ or ▼ cursor buttons and press the **ENTER** button.

FUNC INPUT SETUP 1		DIG	HDMI	COMP	V/S
TV : AUTO	1	-	1	1	1
DVD : AUTO	2	1	2	2	2
VCR : AUTO	3	-	3	3	3
DSS : AUTO	4	2	4	4	4
AUX1 : AUTO	F	-	-	-	*

[RETURN] [NEXT] [EXIT]

2. Select a setting with the ▲, ▼, ◀, and ▶ cursor buttons, and assign a mode and input jack (DIG, HDMI, COMP, V/S).

### MODE

#### AUTO:

Select "**AUTO**", for automatic detection of the digital input signal condition. If there is no digital signal, but there is an analog signal present, the analog signal will be played. "AUTO" is the initial setting of all input sources.

#### HDMI:

Select "**HDMI**", when only a HDMI signal will be used.

#### DIG:

Select "**DIG**", when only a digital signal will be used.

#### ANA:

Select "**ANA**" for input sources for which no digital input jacks are used.

### DIG

5 and F(Front) digital inputs can be assigned to a desired source.

Assign the number of a digital input jack to the device.

### HDMI

Assign the number of an HDMI input jack to the device.

### Note:

- When FUNCTION MODE is set to HDMI and HDMI AUDIO of "5. PREFERENCE" is set to THROUGH, audio is not output from the SR6001. (See page 39)

### COMP

Assign the number of a component video input jack to the device.

### V/S

Assign the number of a composite video and S-video input jack to the device.

### Note:

- Video and S-video can use the same numbers when assigning to input functions.
- The \* mark in AUX.1 indicates that other inputs cannot be assigned.

3. Press the **ENTER** button.
4. Select each mode setting and input terminal with the ◀ or ▶ cursor buttons.
5. Press the **ENTER** button.
6. Repeat steps 2-5 until all items are set.
7. After you complete this portion of the setup, move the cursor to "**NEXT**" with the ▲, ▼, ◀, and ▶ cursor buttons and then press the **ENTER** button to go to the next page.

FUNC INPUT SETUP 2		DIG	HDMI	COMP	V/S
TAPE : ANA	-	-	-	-	1
CD/R : AUTO	5	-	-	-	2
AUX2 : ANA	-	-	-	-	3

[RETURN] [BACK] [EXIT]

8. Repeat steps 2-5 until all items are set. After you complete this portion of the setup, move the cursor to "**RETURN**" with ▲, ▼, ◀, and ▶ cursor buttons and press the **ENTER** button. To return to the Func Input Setup 1 menu from the Func Input Setup 2 menu, move the cursor to "**BACK**" with the ▲, ▼, ◀, and ▶ cursor buttons and press the **ENTER** button.

### Note:

- Assignments cannot be made in sections with a \* mark.

## 1-2 7.1 CH INPUT SETUP

This menu is for adjusting the speaker levels for 7.1-channel input sources.

Here you will adjust the volume for each channel so that they are all heard by the listener at the same level.

1. Select "**7.1 CH INPUT SETUP**" from the 1.INPUT SETUP menu with the ▲ or ▼ cursor buttons and press the **ENTER** button.

7.1 CH INPUT SETUP		LAST
VIDEO-IN :		LAST
FRONT L :		0dB
CENTER :		0dB
FRONT R :		0dB
SURR. R :		0dB
SURR. B R :		0dB
SURR. B L :		0dB
SURR. L :		0dB
SUB W :		0dB

[RETURN] [EXIT]

2. Select "**VIDEO-IN**" with the ▲ or ▼ cursor buttons.
3. Using the ◀ or ▶ cursor buttons, select the video input source to be played through the MONITOR OUT jack.

The input source is switched by pressing the ◀ or ▶ cursor buttons as follows;

**LAST** ↔ **TV** ↔ **DVD** ↔ **VCR** ↔ **DSS** ↔ **AUX1**  
↔ **V-OFF** ↔ **LAST** ↔ ...

### Notes:

- When "**LAST**" is selected, the source is set to the source selected before the 7.1 ch input menu was activated.
- When "**V-OFF**" is selected, no signal is emitted from MONITOR OUT jack.

4. Select desired channel with the ▲ or ▼ cursor buttons.
5. Using the ◀ or ▶ cursor buttons, adjust the volume level of each channel.

Move the cursor to "**RETURN**" with the ▲, ▼, ◀, and ▶ cursor buttons, and press the **ENTER** button to go to the 1.INPUT SETUP menu.

### Note:

- The volume level can be set between -12 dB and +12 dB in 1 dB increments on all channels except the subwoofer (SUB W), which can be set from -18dB to +12 dB in 1 dB increments.

### 1-3 FUNCTION RENAME

Input sources can be registered under any name. This menu is for renaming input source.

This menu is for renaming function name. Names can be up to 10 characters long, including spaces. (Characters are selected from those appearing on the display.) This name appears on the receiver's FL display and the OSD, but it does not appear in the OSD Setup menu.

1. Select "**FUNCTION RENAME**" from the 1. INPUT SETUP menu with the ▲ or ▼ cursor buttons and press the **ENTER** button.



2. Select "**FUNCTION**" with the ▲ or ▼ cursor buttons.
3. Select an input source with the ◀ or ▶ cursor buttons.
4. Select "**RENAME**" with the ▲ or ▼ cursor buttons.
5. Move the cursor to the character (1st to 10th) to change with the ◀ or ▶ cursor buttons.
6. Move the cursor to the character list with the ▼ cursor button. (Move the cursor to the letter "A" to begin with.)
7. Select a character with the ▲, ▼, ◀, and ▶ cursor buttons.
8. Press the **ENTER** button to enter the selected letter.

9. Repeat steps 5-8 until the new name is input.

**BACK:**

Deletes the character left of the cursor in the "**RENAME**" area one character at a time.

**DEFAULT:**

Restores the name in the "**RENAME**" area to the name in the "**FUNCTION**" area.

**SPACE:**

Inserts a space at the cursor point of the "**RENAME**" area.

**Note:**

- RENAME cannot be left blank.

Move the cursor to "**RETURN**" with the ▲, ▼, ◀, and ▶ cursor buttons and press the **ENTER** button to go to the 1. INPUT SETUP menu.

## 2 SPKR (SPEAKER) SETUP

After you have installed the SR6001 connected all the components and determined the speaker layout, it is now time to perform the settings in the Speaker Setup menu for the optimum sound acoustics for your environment and speaker layout.

Before you perform the following settings, it is important that you first determine the following characteristics:

- **AUTO SETUP:**  
“2-1 AUTO SETUP (MultEQ Setup)”  
(see page 31)
- **MANUAL SETUP:**  
“2-2 MANUAL SETUP” (see page 34)

1. Select “2.SPKR SETUP” from the MAIN MENU with ▲ or ▼ cursor buttons and press the ENTER button.

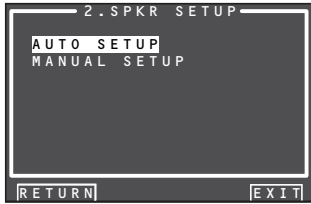

2. Select the desired menu with the ▲ or ▼ cursor buttons, and press the ENTER button.

### Note:

- After you complete this the portion of the setup, press the ENTER button. The cursor will move to “RETURN” and press the ENTER button to go to the Sub-menu.

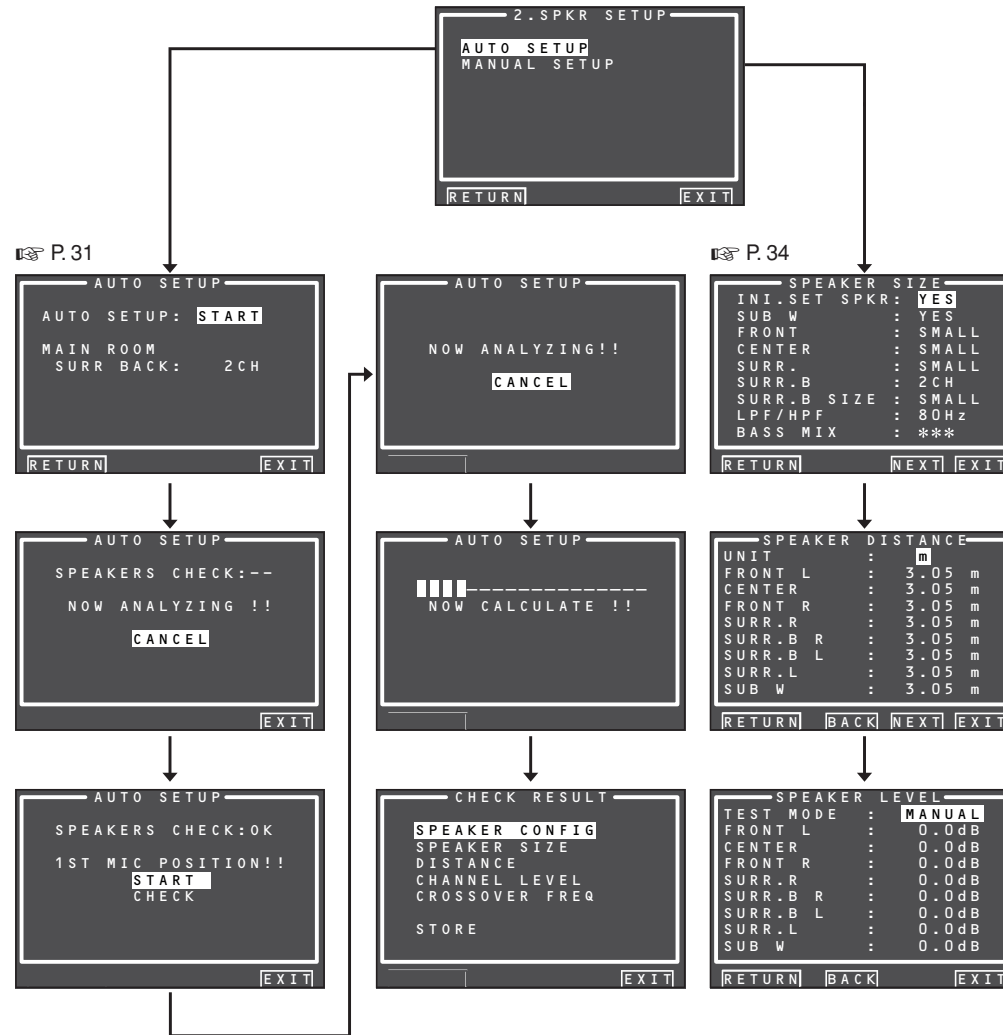

## 2-1 AUTO SETUP (MultEQ™ SETUP)

The AUTO SETUP (MultEQ™ Setup) feature of the SR6001 measures sound characteristics of the speaker system and room where the receiver is used and automatically optimizes settings.

The Audyssey MultEQ™ technology adopted by the SR6001 provides the best listening environment for multiple listeners.

To do this, the AUTO SETUP feature measures a test tone emitted by each channel in a maximum of 6 listening positions, using the supplied microphone. The measurement results are analyzed using an original algorithm and environmental settings are made to improve the sound characteristics of the listening area.

To set up the speaker system (i.e., adjusting speaker distance, etc.) without using the AUTO SETUP feature, see “MANUAL SETUP” on page 34 of the manual.

### HOW TO PERFORM AUTO SETUP

During measurement, the OSD menu displays the condition, therefore turn power to the monitor on.

1. Connect the supplied microphone to the MIC jack on the SR6001.

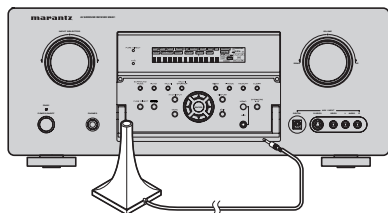

2. Set the microphone in the listening position.

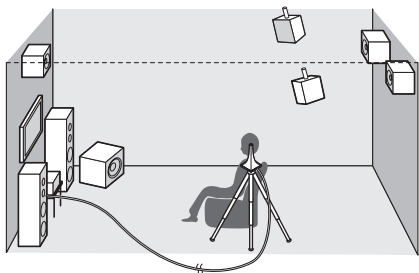

#### Notes:

- Measurement can be done in a maximum of 6 listening positions.
- For the first measurement, set the microphone in the main listening position.

- Use a stand or tripod to position the microphone at ear height in the listening position.
- Remove any obstructions between the speakers and microphone.
- To use the internal subwoofer of the amp, set the volume to the middle point and set the crossover frequency to the highest.
- During measurement, step away from the microphone and operate the SR6001 via the remote control unit from a position that is out of the path of the speaker sound.
- The test tone output from the speakers during measurement is loud. Be mindful of neighbors and watch out for small children.

3. Either press the **MultEQ™** button on the front panel of the SR6001 or select “2. SPKR SETUP” from the MAIN MENU, select “**AUTO SETUP**” with the ▲/▼ cursor buttons, and press the **ENTER** button to display the start screen.

4. Select the number of channels for the surround back speaker you are using.  
For a 5.1 channel speaker system, select “NON” (Surround Back speaker off). (To use speaker C or multi speaker, select “NON”. See page 23, 40.)

Select “**START**” with the ▲/▼ cursor buttons and press the **ENTER** button to start measurement.



5. Detection Check  
During the detection check, the following OSD appears on the display and checks are made to detect dark sound in the listening room, whether there are speakers or not and polarity.

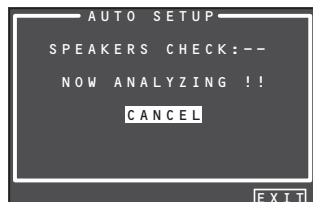

#### Note:

- The detection check measures the state of use of all speakers whether actually used or not.  
For example, if the center speaker is not used, the test tone will require time to go from the L-channel to the R-channel, therefore be careful not to unplug the microphone or operate the SR6001 during this time.

6. When the detection check ends, the following OSD appears on the display.

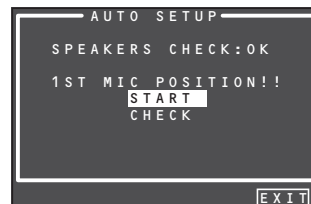

Here, to view the results of the detection check, select “**CHECK**” with the ▲/▼ cursor buttons and press the **ENTER** button. The results will be displayed.



If the check results indicate an error, take suitable action with that item and remeasure. (For error messages, see “ERROR MESSAGES” on page 33.)

After confirming the check results, select “**RETURN**” with the ▲/▼ cursor buttons and press the **ENTER** button to return to the OSD menu.

At this point, you can select “**EXIT**” to end Auto Setup and return to “2. SPKR SETUP”.

## 7. Calibration Check

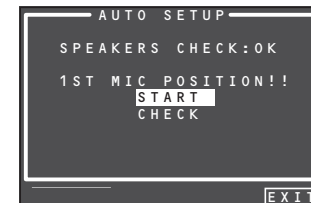

Select “**START**” with the ▲/▼ cursor buttons and press the **ENTER** button to measure the first point (main listening position).

During measurement, the following OSD appears on the display. At this point, you can cancel measurement by selecting “**CANCEL**” with the ▲/▼ cursor buttons and pressing the **ENTER** button.



When this measurement ends, the following OSD appears on the display



8. Move the microphone to the second listening position, select “START” with the ▲/▼ cursor buttons and press the ENTER button to measure the second point. At this point, you can cancel second point measurement and calculate measurement results by selecting “CALCULATE” and pressing the ENTER button.

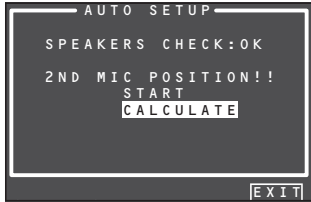

9. Repeat steps 7 and 8 until measuring 6 points between the main listening position and surrounding positions.

When all measurements end, the following OSD appears on the display.



Select “CALCULATE” with the ▲/▼ cursor buttons and press the ENTER button to calculate measurement results. During calculations, the following OSD appears on the display.

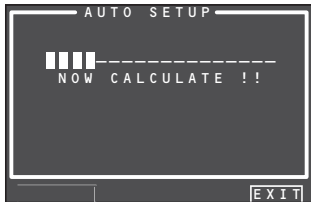

**Note:**

- Less than 6 positions can be measured, but it is recommended to measure in all 6 positions in order to obtain the best results.
- The time needed to complete calculations depends on the number of connected speakers and measured listening positions. The more speakers and listening positions, the more time is needed.

**10. Checking Measurement Results**

When calculations for the measurement results end, a screen appears for confirming the calculation results.

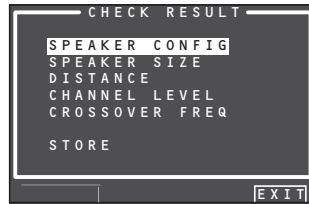

Select items to check with the ▲/▼ cursor buttons and press the ENTER button to enter them.

**Note:**

To check equalizer (MultEQ) parameters, see page 42.

**[Example] Confirmation screen for speaker detection**

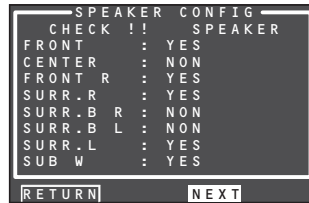

**[Example] Confirmation screen for the distance from speakers to the listening position**

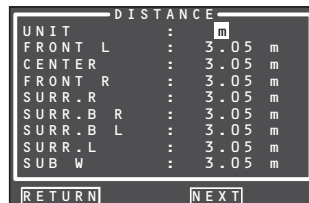

- \* The units can be changed by moving the cursor to [ft] of UNIT and pressing ◀/▶ the cursor buttons. Each time a ◀/▶ cursor button is pressed, the units alternate between [ft] (feet) and [m] (meters).

**[Example] Confirmation screen for speaker size and crossover frequency**

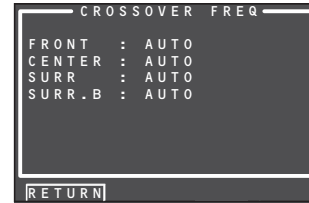
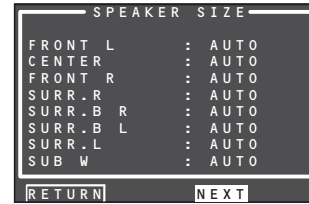

**Note:**

Pressing “EXIT” prior to pressing “STORE” erases all measurement results and calculation results, therefore operate the remote control unit with care.

When storing operations end, the following OSD appears on the display.

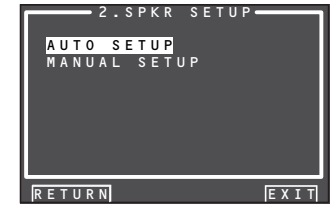

**Note:**

- Do not turn the power to the SR6001 off while storing parameters in memory. This may erase all data in the SR6001’s memory and may damage the receiver.

- \* AUTO is displayed to indicate that the speaker size and crossover frequency results were automatically measured.

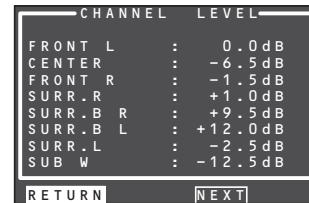

**11. Storing Measurement Results in Memory**

Once finished confirming the measurement results, select “RETURN” with the ▲/▼ cursor buttons and press the ENTER button to display the CHECK RESULT screen.



Place the cursor on “STORE” and press the ENTER button to store all parameters including the equalizer parameters in memory. If not wanting to store the calculation results in memory, place the cursor on “EXIT” and press the ENTER button.

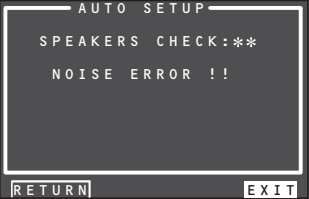
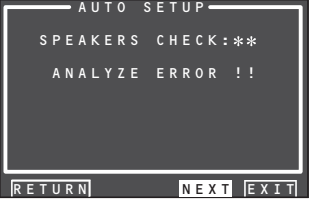

Displayed Error	Cause	How to Remedy
<p>MIC SET ERROR!!</p>  <p>AUTO SETUP            AUTO SETUP: <b>START</b>            MAIN ROOM            SURR BACK: 2CH            MIC SET ERROR!!            RETURN EXIT</p>	<ul style="list-style-type: none"> <li>The microphone is not properly connected.</li> </ul>	<ul style="list-style-type: none"> <li>Connect the included microphone.</li> <li>Check the microphone connection.</li> </ul>
<p>NOISE ERROR!!</p>  <p>AUTO SETUP            SPEAKERS CHECK:**            NOISE ERROR !!            RETURN EXIT</p>	<ul style="list-style-type: none"> <li>There is too much noise in the listening room to measure properly.</li> <li>Volume from the speakers is low.</li> </ul>	<ul style="list-style-type: none"> <li>During measurement, turn off devices that make noise such as air conditioners.</li> <li>Measure at a time when the surrounding area is quiet.</li> </ul>
<p>ANALYZE ERROR!!</p>  <p>AUTO SETUP            SPEAKERS CHECK:**            ANALYZE ERROR !!            RETURN NEXT EXIT</p> <p>* Under ANALYZE ERROR, select "NEXT" with the ▲/▼ cursor buttons and press the <b>ENTER</b> button. A detail screen like the following appears on the display.</p>  <p>SPEAKER CONFIG            CHECK !! SPEAKER            FRONT L : YES REV            CENTER : NON            FRONT R : YES REV            SURR.R : NON ERR            SURR.B R : YES ERR            SURR.B L : YES ERR            SURR.L : NON ERR            SUB W : YES            RETURN EXIT</p>	<ul style="list-style-type: none"> <li>The speakers required for suitable playback were not detected.</li> <li>Speaker polarity is connected backwards.</li> </ul> <p>In the examples at left, the following trouble is detected.</p> <ul style="list-style-type: none"> <li>The polarity of the left and right channels of the front speakers is backwards ([REV] appears on the display.)</li> <li>The surround speaker is not connected ([NON] is displayed), but the surround back speaker is connected (In this kind of situation, [ERR] is displayed for all surround and surround back speakers.)</li> </ul> <p>An error is indicated in addition to the above if the speakers are connected as follows.</p> <ul style="list-style-type: none"> <li>When using just one surround back speaker, but it is connected to the surround back R-channel (To use just one surround back speaker, connect it to the L-channel.)</li> </ul>	<ul style="list-style-type: none"> <li>Check the speaker that is indicated as having reversed polarity ([REV] can appear with some speakers even when properly connected. In such case, ignore the error indication.)</li> <li>Check speaker direction and layout</li> </ul>

## 2-2 MANUAL SETUP

- Select "2. SPKR SETUP" from the MAIN MENU.
- Select "MANUAL SETUP" with the ▲ or ▼ cursor buttons.
- Press the ENTER button to enter the selection.

## &lt;SPEAKER SIZE&gt;

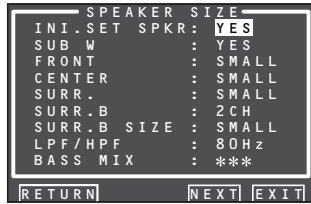

When setting the speaker size in the SPEAKER SIZE menu, use the guidelines below.

**INI. SET SPKR (Initial Setting Speaker):**

Setting this to YES allows the following settings to be restored. To change the settings, select "CUSTOM."

- The front, center and surround speaker size should be "SMALL".
- The subwoofer should be "YES".
- LPF/HPF (the crossover frequency) should be "80Hz".

**LARGE:**

The complete frequency range for the channel you are setting will be output from the speaker.

**SMALL:**

Frequencies of the channel you are setting that are lower than approx. 80 Hz will be output from the subwoofer.

If the SUB. W is set to "NONE" and the front speakers are set to "LARGE," then the sound will be output from both the left and right speakers.

- Select each speaker with the ▲ or ▼ cursor buttons.
- Set the size of each speaker with the ◀ or ▶ cursor buttons.
- After you complete this portion of the setup, move the cursor to "NEXT" with the ▲, ▼, ◀ and ▶ cursor buttons and press the ENTER button to go to the next page.

**SUB W****YES:**

Select when a subwoofer is connected.

**NO:**

Select when a subwoofer is not connected.

**FRONT****LARGE:**

Select if the front speakers are large.

**SMALL:**

Select if the front speakers are small.

- If "NO" is selected for the subwoofer setting, then this setting is fixed at "LARGE".

**CENTER****NONE:**

Select if no center speaker is connected.

**LARGE:**

Select if the center speaker is large.

**SMALL:**

Select if the center speaker is small.

**SURR.****NONE:**

Select if no surround left and right speakers are connected.

**LARGE:**

Select if the surround left and right speakers are large.

**SMALL:**

Select if the surround left and right speakers are small.

**SURR. B****NONE:**

Select if no surround back left and right speakers are connected.

**2CH:**

Select if the surround back left and right speakers are connected.

**1CH:**

Select if one surround back speaker is connected. In this case, the audio signal is emitted from the SURR BACK LEFT output terminal.

**Notes:**

- If "NONE" is selected for the SURR. setting, then this setting is fixed to "NONE."

**SURR. BACK SIZE****LARGE:**

Select if the surround back speakers are large.

**SMALL:**

Select if the surround back speakers are small.

**Note:**

- If "NONE" is selected for the SURR. setting, then this setting is not available.

**LPF/HPF**

When you use a subwoofer, you can select the cutoff frequency for the small speakers used. Select one of the crossover frequency levels according to the size of the small speakers connected.

60Hz → 80Hz → 100Hz → 120Hz → 140Hz → 160Hz → 180Hz

**Note:**

- If using small front speakers, set a slightly higher frequency. If using large front speakers, set a slightly lower frequency.

**BASS MIX**

- The bass mix setting is only valid when "LARGE" is set for the front speakers and "YES" is set for the subwoofer during stereo playback.

This setting has effect only during playback of PCM or analog stereo sources.

- When "BOTH" is selected, the low frequencies will be played through the main L&R speakers and the subwoofer.

In this playback mode, the low frequency range expands more uniformly throughout the room, but depending on the size and shape of the room, interference may result in a decrease of the actual volume of the low frequency range.

- By selecting "MIX", the low frequencies will play through the main L&R only.

**Note:**

- LFE signals during playback of Dolby Digital or DTS will be played through the subwoofer.

- After you complete this portion of the setup, move the cursor to "NEXT" with the ▲, ▼, ◀ and ▶ cursor buttons and press the ENTER button to go to the next page.

## &lt;SPEAKER DISTANCE&gt;

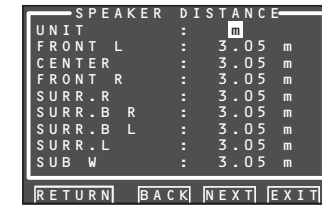

Use this menu to specify the distance of each speaker's position from the listening position. The delay time is automatically calculated according to these distances.

Begin by determining the ideal or most commonly used seating position in the room.

This is important for the timing of the acoustics to create the proper sound space that the SR6001 and today's sound systems are able to produce.

**Note:**

- For speakers for which you have selected "NONE", the speaker configuration sub-menu will not appear here. (There are several useful books and special DVD and LD's available to guide you through proper home theater configuration. If you are unsure, have your Marantz dealer perform the installation for you. They are trained professionals familiar with even the most sophisticated custom installations. Marantz recommends the [www.cedia.org](http://www.cedia.org) website for further information.)

- Select either m (meters) or ft (feet) for UNIT with the ◀ or ▶ cursor buttons.

- Select each speaker with the ▲ or ▼ cursor buttons.

- Set the distance for each speaker, press the ◀ or ▶ cursor buttons.

**FRONT L:**

Set the distance from the front left speaker to your normal listening position.

**CENTER:**

Set the distance from the center speaker to your normal listening position.

**FRONT R:**

Set the distance from the front right speaker to your normal listening position.

**SURR. L:**

Set the distance from the surround left speaker to your normal listening position.

**SURR. R:**

Set the distance from the surround right speaker to your normal listening position.

**SUB W:**

Set the distance from the subwoofer to your normal listening position.

**SURR. B L:**

Set the distance from the surround back left speaker to your normal listening position.

**SURR. B R:**

Set the distance from the surround back right speaker to your normal listening position.

**Notes:**

- Set the distance to each speaker in meters (m) or feet (ft) as follows.  
m: 0.03 - 9.15 m in 0.03 m steps  
ft: 0.1 - 30.0 ft in 0.1 ft steps  
(The values appearing on the FL display are approximate.)
- For the speakers that you have selected “NONE” the speaker size menu will not appear.
- The setting for surr.back L and surr.back R appears if it is set, two surround back speakers in the SPEAKER SIZE menu.
- The setting of SURR. BACK appears if it is set for one surround back speaker in the SPEAKER SIZE menu.

- 11.** After you complete this portion of the setup, move the cursor to “NEXT” with the ▲, ▼, ◀ and ▶ cursor buttons and press the **ENTER** button to go to the next page.

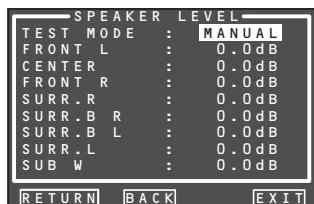
**<SPEAKER LEVEL>**

Here you can set the volume for each speaker so that they are all heard by the listener at the same level. We recommend holding a dB SPL (Sound Pressure Level) meter at the listening position, at arms length, and pointing straight up at the ceiling, adjust the level of each speaker in turn until it reads 75dB SPL when the meter is set to “C” weighting and Slow response.

**Note:**

- The speaker level settings are not available in 7.1 Channel Input mode, Pure Direct mode and Source Direct mode.

**TEST MODE:**

Select “MANUAL” or “AUTO” generation of the test tone with the ◀ or ▶ cursor buttons.

If you select “AUTO”, the test tone will be cycled through in a circular pattern beginning at **Left** → **Center** → **Right** → **Surround Right** → **Surround Back Right** → **Surround Back Left** → **Surround Left** → **Subwoofer** → **Left**, in 2 seconds increments for each channel.

Using the ◀ or ▶ cursor buttons, adjust the volume level of the noise from the speaker so that it is the same level for all the speakers.

If you select “MANUAL”, adjust the output level of each speaker as listed below.

- 12.** Move the cursor to FRONT L by pressing the ▼ cursor button. The SR6001 will emit a pink noise from the front left speaker.

Remember the level of this noise and then press the ▼ cursor button.

(Note that this can be adjusted to any level between -12 and +12 dB in 0.5 dB increments.)

The SR6001 will now emit the pink noise from the center speaker.

- 13.** Using the ◀ and ▶ cursor buttons, adjust the volume level of the noise from the center speaker so that it is the same level as the front left speaker.

- 14.** Press the ▼ cursor button again. The SR6001 will now emit the pink noise from the front right speaker.

- 15.** Repeat steps 13 and 14 for the front right and other speakers until all speakers are adjusted to the same volume level.

After you complete this portion of the setup, press the **ENTER** button to move the cursor to “RETURN”. Press the **ENTER** button to go to “2. SPKR SETUP”.

**Notes:**

- Speakers for which you selected “NONE” in the SPEAKER SIZE menu will not appear.
- Surr. Back L and Surr. Back R appear if it is set for two surround back speakers in the SPEAKER SIZE menu.
- Surr. Back appears if it is set for one surround back speaker in the SPEAKER SIZE menu.
- To adjust the speaker levels for 7.1 channel input sources, you will need to use the 7.1 Ch Input sub menu. (See page 36)
- SUB W can be set from -18dB to +12dB.

### 3 SURROUND SETUP

This menu is for setting surround effect parameters for the various surround input signals so as to bring out the live audio effect of your speaker system.

- **CHANNEL LEVEL:**  
"3-1 CHANNEL LEVEL" (see page 36)
- **PLIIx MUSIC PARAMETER:**  
"3-2 PLIIx MUSIC PARAMETER" (see page 37)
- **CSII PARAMETER:**  
"3-3 CSII PARAMETER" (see page 37)
- **NEO:6 PARAMETER:**  
"3-4 NEO:6 PARAMETER" (see page 37)

1. Select "3. SURR SETUP" from the MAIN MENU with the ▲ or ▼ cursor buttons and press the ENTER button.
2. Select the desired menu with the ▲ or ▼ cursor buttons and press the ENTER button.



#### HT-EQ:

Select to active the HT-EQ with the ◀ or ▶ cursor buttons.

The tonal balance of a film soundtrack will be excessively bright and harsh when played back over audio equipment in the home. This is because film soundtracks were designed to be played back in large movie theater environments.

Activating the HT-EQ feature when watching a film made for movie theaters corrects this and restores the correct tonal balance.

The HT-EQ feature is available except in the following modes.

- 7.1 CH INPUT
- PURE-DIRECT
- When Dolby Virtual Speaker is set for the surround mode

#### LFE LEVEL:

Select the output level of the LFE signal included in the Dolby Digital signal or the DTS signal.

Select "0dB", "-10 dB" or "OFF" with ◀ or ▶ cursor button.

After you complete this portion of the setup, move the cursor to "RETURN" with the ▲, ▼, ◀, ▶ cursor buttons and press the ENTER button.

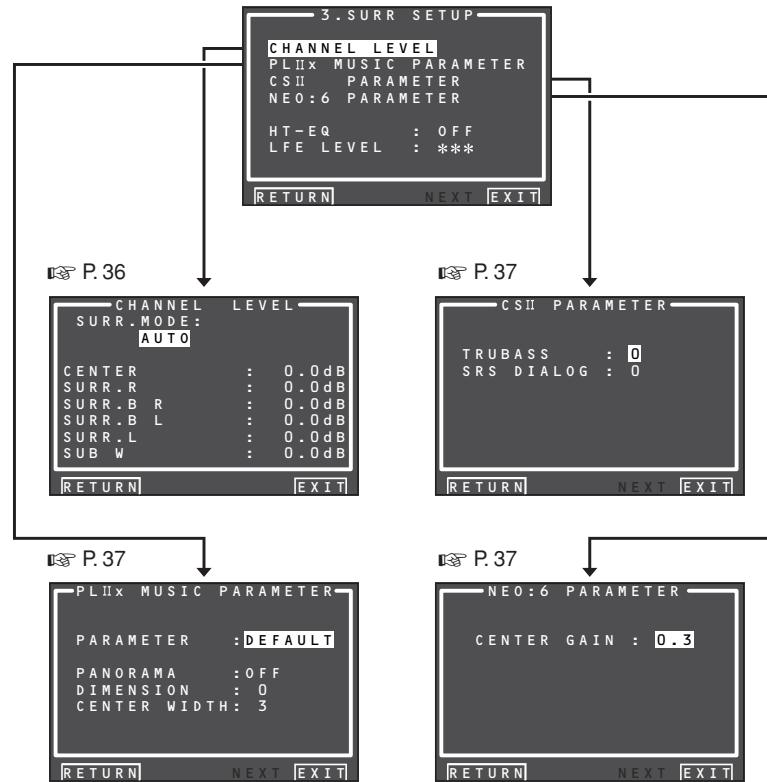

### 3-1 CHANNEL LEVEL

1. Select "3. SURR SETUP" from MAIN MENU with ▲ or ▼ cursor buttons and press the ENTER button.
2. Select "CHANNEL LEVEL" with the ▲ or ▼ cursor buttons and press the ENTER button.
3. Set the SURR. MODE with the ◀ or ▶ cursor buttons.

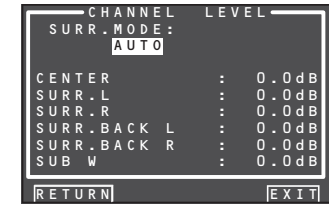

4. Select the desired menu item with the ▲ or ▼ cursor buttons, set the desired level with the ◀ or ▶ cursor buttons, and press the ENTER button.

#### SURROUND MODE:

The surround mode can be independently set for 3 modes.

1. Multi Ch STEREO
2. CSII
3. Others

#### CHANNEL LEVEL

##### CENTER LEVEL:

Set the effect level of the center speaker between -12 and +12 level in 0.5 level interval .

- If "NONE" was selected for the center speaker setting in the SPEAKER SIZE, then this setting will not appear.

##### SURR L or R LEVEL:

Set the effect level of the Surround speaker between -12 and +12 level in 0.5 level interval .

- If "NONE" was selected for the surround speakers setting in the SPEAKER SIZE, then this setting will not appear.

##### SURR. BACK L or R LEVEL:

Set the effect level of the Surround Back speaker between -12 and +12 level in 0.5 level interval .

- If "NONE" was selected for the surround back speakers setting in the SPEAKER SIZE, then this setting will not appear.

#### Note:

- After you complete this portion of the setup, press the ENTER button to move the cursor to "RETURN" and press the ENTER button again to go to sub-menu.

**SUB W LEVEL:**

Set the effect level of the subwoofer speaker between **-18** and **+12** level in 0.5 level interval .

- If “**NONE**” was selected for the subwoofer speaker setting in the **SPEAKER SIZE**, then this setting will not appear.

**Note:**

- Setting to a mode other than multichannel stereo or CSII will affect the speaker level as explained in “2-2 MANUAL SETUP”.

After you complete this portion of the setup, move the cursor to “**RETURN**” with the **▲**, **▼**, **◀** and **▶** cursor buttons and press the **ENTER** button to go to the **3. SURR SETUP** menu.

**3-2 PLIIx (PRO LOGIC IIx) MUSIC PARAMETER**

Pro LogicIIx-Music mode creates a rich and enveloping surround ambience from stereo sources such as CDs.

In this mode, the SR6001 includes three controls to fine-tune the sound field as follows.

1. Select “**3. SURR SETUP**” in MAIN MENU with **▲** or **▼** cursor buttons and press the **ENTER** button.
2. Select “**PLIIx MUSIC PARAMETER**” with the **▲** or **▼** cursor buttons.
3. Press the **ENTER** button to enter the selection.

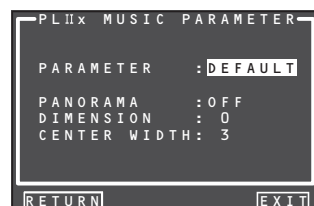
**PARAMETER:**

Select “**DEFAULT**” or “**CUSTOM**” with the **◀** or **▶** cursor buttons.

If you select “**CUSTOM**”, you can adjust three parameters as listed below.

**PANORAMA:**

Select the PANORAMA mode “**ON**” or “**OFF**” with the **◀** or **▶** cursor buttons.

Panorama wraps the sound of the front left and right speakers around you, for an exciting perspective.

**DIMENSION:**

Set the DIMENSION level between **0** and **6** level in 1 level intervals with the **◀** or **▶** cursor buttons.

Adjust the sound field either towards the front or towards the rear.

This can be useful to help achieve a more suitable balance from all the speakers with certain recordings.

**CENTER WIDTH:**

Set the CENTER WIDTH level between **0** and **7** in 1 level intervals with the **◀** or **▶** cursor buttons.

Center width allows you to gradually spread the center channel sound into the front left and right speakers.

At its widest setting, all the sound from the center is mixed into the left and right speakers.

This control may help achieve a more spacious sound or a better blend for the front image.

If “**NONE**” was selected for the center speaker

setting in the **SPEAKER SIZE** menu, this setting cannot be selected.

After you complete this portion of the setup, move cursor to “**RETURN**” with the **▲**, **▼**, **◀** and **▶** cursor buttons and press the **ENTER** button.

**3-3 CSII PARAMETER**

1. Select “**3. SURROUND SETUP**” from MAIN MENU with the **▲** or **▼** cursor buttons and press the **ENTER** button.
2. Select “**CS II PARAMETER**” with the **▲** or **▼** cursor buttons.
3. Press the **ENTER** button to enter the selection.

**TRUBASS:**

Set the TRUBASS level between **0** and **6** in 1-level increments with the **◀** or **▶** cursor buttons.

TRUBASS produced by the speakers are an octave below the actual physical capabilities of the speakers adding exciting, deeper bass effects.

**SRS DIALOG:**

Set the SRS DIALOG level between **0** and **6** in 1-increments with the **◀** or **▶** cursor buttons.

This can be popped out of the surround audio effects, allowing the listener to easily discern what the actors say.

If “**NONE**” was selected for the center speaker setting in the **SPEAKER SIZE** menu, this setting cannot be selected.

After you complete this portion of the setup, move cursor to “**RETURN**” with the **▲**, **▼**, **◀** and **▶** cursor buttons and press the **ENTER** button.

**Note:**

- This parameter can only be set in the CSII mode.

**3-4 NEO:6 PARAMETER**

The DTS NEO:6 mode enables a maximum 6.1 channel output with just 2 channel input. (It also supports 5.1 channel input.)

This mode expands the sound image from the center channel.

1. Select “**3. SURROUND SETUP**” from MAIN MENU with the **▲** or **▼** cursor buttons and press the **ENTER** button.
2. Select “**NEO:6 PARAMETER**” with the **▲** or **▼** cursor buttons.
3. Press the **ENTER** button to enter the selection.

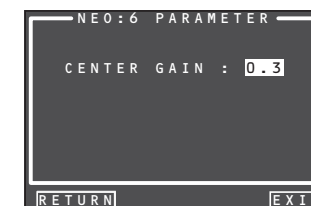

4. Set the CENTER GAIN level between 0.0 and 1.0 in 0.1 level increments with the **◀** or **▶** cursor buttons.

After you complete this portion of the setup, move cursor to “**RETURN**” with the **▲**, **▼**, **◀** and **▶** cursor buttons and press the **ENTER** button.

**Notes:**

- This parameter can only be set in the NEO:6-Music mode.
- If “**NONE**” was selected for the center speaker setting in the **SPEAKER SIZE** menu, this setting is disabled.



## 4 VIDEO SETUP

Video settings are made as follows.

1. Select "4. VIDEO SETUP" from the MAIN MENU with the ▲/▼ cursor buttons and press the **ENTER** button.

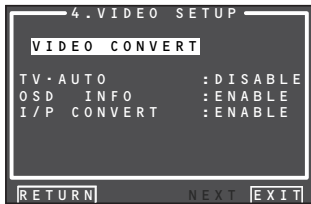

2. Select the desired menu with the ▲/▼ cursor buttons and press the **ENTER** button.

- **VIDEO CONVERT**

"4-1 VIDEO CONVERT"

- **TV-AUTO**

Select the TV AUTO ON/OFF function to enable or disable with the ◀ or ▶ cursor buttons. (refer to page 49)

- **OSD INFO**

Select the OSD information function to "ENABLE" or "DISABLE" with the ◀ or ▶ cursor buttons. If you select "ENABLE", the SR6001 will display the status of the feature (Volume up/down, input select, etc.) on the monitor. If you do not desire this information, select "DISABLE".

**Note:**

- OSD information is not output to Monitor Output of HDMI and Component Video. However, OSD information is output if the Video Convert function is used to output Video or S-Video video signals to Monitor Out of HDMI and Component Video.

For details, refer to "VIDEO CONVERT" on page 44.

- **IP CONVERT**

Select the IP CONVERT ON/OFF function to enable or disable with the ◀ or ▶ cursor buttons. (refer to page 44)

After you complete this portion of the setup, move cursor to "RETURN" with the ▲, ▼, ◀ and ▶ cursor buttons and press the **ENTER** button.

## 4-1 VIDEO CONVERT

The SR6001 is equipped to convert video signals for monitor output.

This section explains how to set up conversion for each type of video input.

1. Select "4. VIDEO SETUP" from the MAIN MENU with the ▲ / ▼ cursor buttons and press the **ENTER** button.
2. Select "VIDEO CONVERT" with the ▲ / ▼ cursor buttons and press the **ENTER** button.

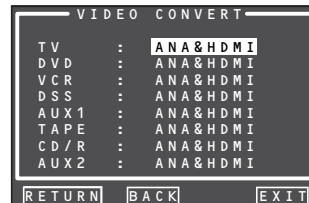

3. Select "FUNCTION" with the ▲ / ▼ cursor buttons and set the video conversion mode with the ◀ / ▶ cursor buttons

**ANA&HDMI:**

This mode both up-converts and down-converts analog video signals (Composite Video, S-Video, Component Video). Furthermore, it up-converts from analog video signal to HDMI. (It cannot down-convert from HDMI digital video signals to analog video signals.)

**ANA ONLY:**

This mode both up-converts and down-converts analog video signals (Composite Video, S-Video, Component Video). It does not up-convert to HDMI.

**OFF:**

This mode turns off all conversion features.

**Note:**

- For details on video convert feature, see page 44.

## 5 PREFERENCE

- **MULTI ROOM SETUP :**  
"5-1 MULTI ROOM SETUP" (see page 40)
- **DC TRIGGER SETUP :**  
"5-2 DC TRIGGER SETUP" (see page 40)

1. Select "5. PREFERENCE" from MAIN MENU with the ▲ or ▼ cursor buttons and press the ENTER button.

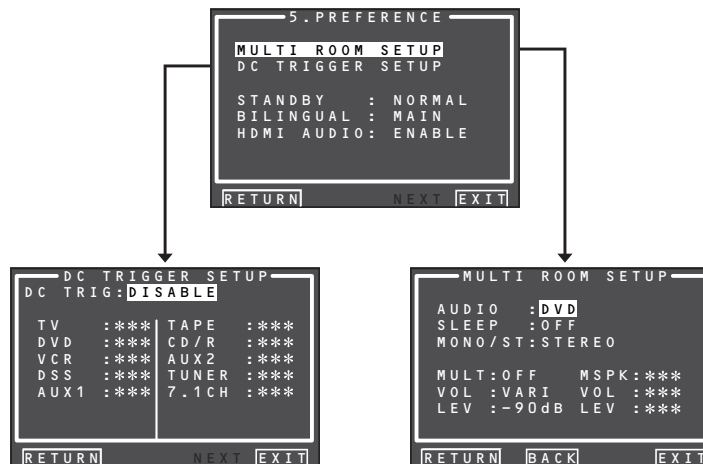
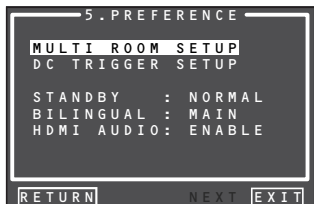

2. Select the desired menu with the ▲ or ▼ cursor buttons and press the ENTER button.

### STAND BY:

When this is set to "ECONOMY", you can reduce the power consumption when the unit is in the Standby mode. When "ECONOMY" is selected, "TV AUTO" and "RS-232C" are disabled when the unit is in the Standby mode.

### BILINGUAL:

In the Bilingual mode, Dolby Digital and DTS output is set to either "MAIN" or "SUB". Select "BILINGUAL" with the ◀ or ▶ cursor buttons, then select MAIN ↔ SUB ↔ MAIN+SUB with the ◀ or ▶ cursor buttons.

### HDMI AUDIO:

This setting determines whether to play back audio input to the HDMI jacks through the SR6001 or output it through the receiver to a TV or projector.

**ENABLE:** The audio input to the HDMI jacks can be played back by this receiver. In such case, audio signals are not output to the TV or projector.

**THROUGH:** The audio input to the HDMI jacks is not output from the speaker terminals of the SR6001. Audio data is output directly to the TV or projector. This setting is used to listen to audio on a multi channel TV, etc.

After you complete this portion of the setup, move the cursor to "RETURN" with the ▲, ▼, ◀ and ▶ cursor buttons and press the ENTER button.

## 5-1 MULTI ROOM SETUP

The SR6001 has source selectors, sleep timers and multispeaker output remote control units for the other rooms in the multi room system.

These features can be set from this menu.

1. Select "5. PREFERENCE" from the MAIN MENU with the ▲ or ▼ cursor buttons and press the **ENTER** button.
2. Select "MULTI ROOM SETUP" with the ▲ or ▼ cursor buttons.
3. Press the **ENTER** button to enter the setting.

The following explanation shows how to operate MULTI ROOM of the multi-room system.



4. Select the desired item with the ▲ or ▼ cursor button.

### AUDIO:

Select the audio source of the multiroom output with the ◀ or ▶ cursor buttons.

### SLEEP:

The sleep mode is available when the multiroom is active, set the time with ◀ or ▶ cursor buttons. The sleep timer can be set to a maximum 90 minutes in 10 minute increments.

### MONO/ST:

This mode switches audio output to the multi room system between MONAURAL and STEREO, using the ◀ and ▶ cursor buttons.

### MULTI (MULTI ROOM):

Switch the multiroom output "ON" or "OFF" with the ◀ or ▶ cursor buttons.

### MSPK (MULTI SPEAKER):

Switch the speaker output "ON" or "OFF" with the ◀ or ▶ cursor buttons.

### VOL (VOLUME SETUP):

Select whether the multiroom or multi speaker output level is variable or fixed with the ◀ or ▶ cursor buttons.

### LEVEL (VOLUME LEVEL):

Adjust the multiroom output level with the ◀ or ▶ cursor buttons. The volume can be set between -90 dB and 0 dB in 1 dB increments.

#### Note:

- This setting can be changed when the SURR B is set to "NONE" in the SPEAKER SIZE menu and "SPEAKER C" is in the OFF position on the rear panel. When this setting is unavailable, "\*\*\*" is displayed.
- If "VOLUME" is set to "FIXED", the multiroom output level cannot be adjusted from the A or B room.

## 5-2 DC TRIGGER SETUP

This unit has DC trigger control jack, which is linked with input functions of main room or multiroom, and controls DC trigger output.

Each trigger can be setup separately.

1. Select "5. PREFERENCE" from MAIN MENU with the ▲ or ▼ cursor buttons and press the **ENTER** button.
2. Select "DC TRIGGER SETUP" with the ▲ and ▼ cursor buttons.
3. Press the **ENTER** button to enter the selection.

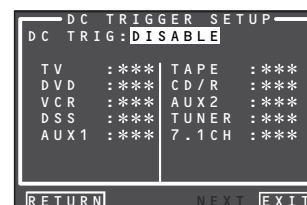

4. You can select "MAIN ROOM", "MULTI ROOM", "REMOTE" or "DISABLE" with the ◀ or ▶ cursor buttons.

#### Note:

- REMOTE is available for the external control. The RC5001SR cannot operate the function.

5. Select desired input source with the ▲ or ▼ cursor buttons.
6. Set to "ON" or "OFF" with the ◀ or ▶ cursor buttons.
7. After you complete this portion of the setup, move the cursor to "RETURN" with the ▲ or ▼ cursor button and press the **ENTER** button.

#### Note:

- When an input source that is on in the set room is selected, voltage is output to the DC TRIGGER output terminal.

## 6 ACOUSTIC EQ

This display is for setting up the equalizer and changing the Equalizer mode.

- **PRESET G. EQ ADJ :**  
"6-1 PRESET G. EQ ADJ" (see page 42)
- **CHECK AUTO :**  
"6-2 CHECK AUTO" (see page 42)

**EQ MODE:**  
There are 4 equalizer modes to choose from: PRESET G. EQ that allows the user to manually adjust the equalizer, and AUDYSSEY, FRONT and FLAT that automatically adjust the equalizer from the measurement results of the AUTO SETUP feature (see page 31).

**AUDYSSEY:**  
This mode adjusts the frequency characteristics of all speakers so as to create the best listening environment for the sound characteristics of the listening room.

**FRONT:**  
This mode matches the characteristics of each speaker to those of the front speakers.

**FLAT:**  
This mode flattens the frequency characteristics of all speakers. It is suited for playback of multichannel music such as Dolby Digital and DTS.

**PRESET:**  
This mode adjusts the graphic equalizer that S characteristics of each speaker (see page 42).

**OFF:**  
The graphic equalizer is not used.

1. Select "6. ACOUSTIC EQ" from MAIN MENU with the ▲ or ▼ cursor buttons and press the ENTER button.

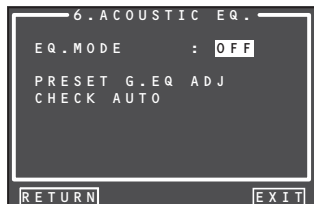

2. Select "EQ. MODE" with the ▲ or ▼ cursor buttons.

3. Select "FRONT", "FLAT", "AUDYSSEY", "PRESET" or "OFF" with the ◀ or ▶ cursor buttons.

After you complete this portion of the setup, move the cursor to "RETURN" with the ▲, ▼, ◀ and ▶ cursor buttons and press the ENTER button.

- Note:**
- "AUDYSSEY", "FRONT" and "FLAT" can be selected after executing the AUTO SETUP feature.
  - If a speaker that was determined "NON" in Auto Setup is manually turned on, the "AUDYSSEY", "FRONT" and "FLAT" modes cannot be selected.
  - The equalizer turns off when the Pure Direct mode, Source Direct mode, Dolby Headphone or Virtual mode is set.

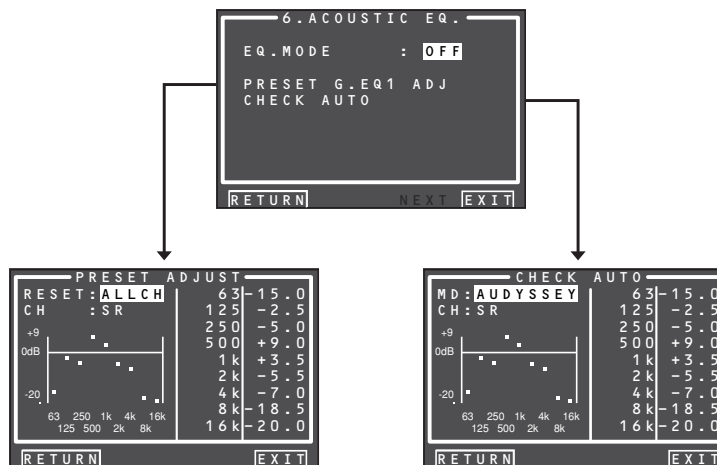

## 6-1 PRESET G. EQ ADJ

These modes allow you to set a 9-band graphic equalizer for each of the 7 channels.

1. Select **"6. ACOUSTIC EQ"** from MAIN MENU with the ▲ or ▼ cursor buttons and press the **ENTER** button.
2. Select **"PRESET G. EQ ADJ"** with the ▲ or ▼ cursor buttons.
3. Press the **ENTER** button to enter the selection.

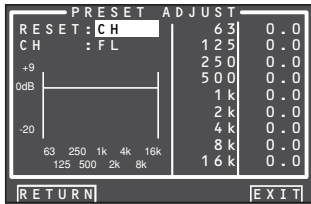

### RESET:

Using the ◀ or ▶ cursor buttons, select the channel(s) to be reset to either the currently displayed channel ("CH") or all channels ("ALL"), and press the **ENTER** button to enter the setting.

"ALL" : Resets all channels.

"CH" : Resets only the currently displayed channel.

### CH:

Select the channel ("FL", "C", "FR", "SR", "SBR", "SBL" or "SL") to adjust with the ◀ or ▶ cursor buttons, and switch to the adjustment mode with the ▼ cursor button.

### Frequency:

Select the target frequency on the graph with the ◀ or ▶ cursor buttons and press the **ENTER** button to enter the selection. Adjust the level with the ▲ or ▼ cursor buttons. (Note that this can be adjusted to any level between **-20** and **+9** dB in 0.5 dB increments.)

Move to the next frequency with the ◀ or ▶ cursor buttons, and adjust the level.

After you complete this portion of the setup, press the **ENTER** button to enter the settings. Move cursor to **"RETURN"** with the ▲, ▼, ◀ and ▶ cursor buttons and press the **ENTER** button.

## 6-2 CHECK AUTO

These menus are for confirming the results of AUTO SETUP function equalizer measurement (AUDYSSEY, FRONT, FLAT).

1. Select **"6. ACOUSTIC EQ"** from MAIN MENU with the ▲ or ▼ cursor buttons and press the **ENTER** button.
2. Select **"CHECK AUTO"** with the ▲ or ▼ cursor buttons.
3. Press the **ENTER** button to enter the selection.

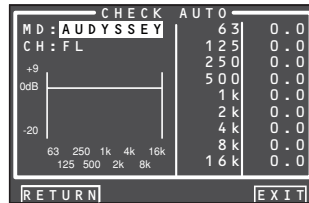

Select MD (mode) with the ▲ / ▼ cursor buttons followed by the desired equalizer ("AUDYSSEY", "FRONT", "FLAT").

### CH:

Select the channel to check with the ◀ or ▶ cursor buttons.

### Notes:

- The frequency will not be exactly the same as in the Preset G. EQ modes.
- FL and FR are not indicated on the CHECK AUTO 2 menu.

4. Once finished checking, select **"RETURN"** with the ▲ / ▼ cursor buttons and press the **ENTER** button to return to the "6. ACOUSTIC EQ" menu.



# BASIC OPERATION

## (PLAY BACK)

### SELECTING AN INPUT SOURCE

Before you can listen to any input media, you must first select the input source on the SR6001.

#### Example : DVD

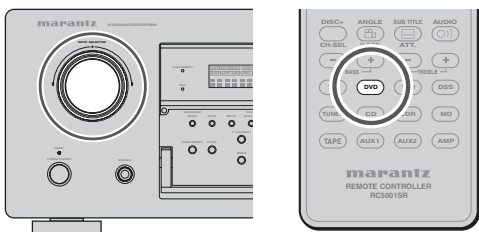

To select DVD, turn the **INPUT SELECTOR** knob on the front panel or press the **DVD** button on the remote two times in a row. After you have selected DVD, simply turn on the DVD player and play the DVD.

- As the input source is changed, the new input name will appear momentarily on the video display. The input name will also appear in the display, on the front-panel.
- If you use the **FUNCTION RENAME** feature (see page 29), the renamed name appears on the display.
- As the input is changed, the SR6001 will automatically switch to the digital input, surround mode, attenuation, and night mode status which were entered during the configuration process for that source.
- When an audio source is selected, the last video input used remains routed to the **VCR & DSS** Outputs and **Monitor** Output. This permits simultaneous viewing and listening to different sources.
- When a video source is selected, the selected video signal is output from the **MONITOR OUT** terminal.

### SELECTING THE SURROUND MODE

#### Example: AUTO SURROUND

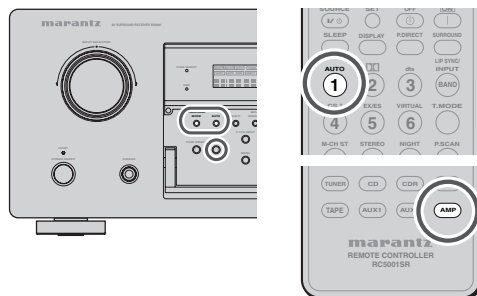

#### (Using the SR6001)

To select the Auto surround mode during playback, press the **AUTO** button on the front panel.

#### (Using the remote control unit)

To select the Auto surround mode, press the **AMP** button first to enter the AMP mode then press the **AUTO** button.

- For surround modes, see "Surround Mode" on page 45.
- To select a specific surround mode, Press the individual surround mode button on page 9 on the remote control unit.

### ADJUSTING THE MAIN VOLUME

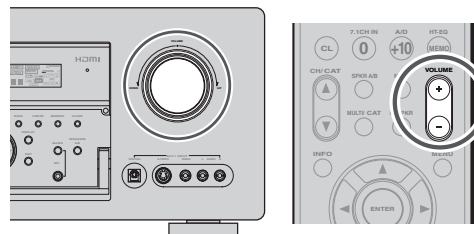

Adjust the volume to a comfortable level using the **VOLUME** control knob on the front panel or **VOLUME + / -** buttons on the remote.

To increase the volume, turn the **VOLUME** knob clockwise or press **VOLUME +** button on the remote, to decrease the volume, turn counterclockwise or press **VOLUME -** button on the remote.

#### Notes:

- The volume can be adjusted within the range of  $- \infty$  to 18 dB, in steps of 1 dB.
- However, when the channel level is set as described on page 36, if the volume for any channel is set at +1 dB or greater, the volume cannot be adjusted up to 18 dB. (In this case the maximum volume adjustment range is "18 dB - Maximum value of channel level")

### NIGHT MODE



#### (Using the remote control unit)

Press the **NIGHT** button to turn on the Night mode. Setting the Night mode to "ON" compresses the dynamic range in Dolby Digital only.

This softens loud passages such as sudden explosions, to help prevent disturbing others late at night. To turn off the Night mode, Press the **NIGHT** button again.

### ADJUSTING THE TONE (BASS & TREBLE) CONTROL



During a listening session you may wish to adjust the Bass and Treble Control to suit your listening tastes or room acoustics.

#### (Using the remote control unit)

To adjust the bass effect, press **BASS+** or **BASS-**. To adjust the treble effect, **TREBLE+** or **TREBLE-**.

#### Notes:

- The tone control function is unavailable for the Source Direct, Pure Direct, Dolby Headphone, Dolby Virtual Speaker and 192kHz PCM.
- The tone control function is not available when **ACOUSTIC EQ** is used.

### DIALOGUE NORMALIZATION MESSAGE

Dialogue Normalization (Dial Norm) is a feature of Dolby Digital.

When playing back software which has been encoded in Dolby Digital, sometimes you may see a brief message on the FL display which will read "D-NORM" (X being a numeric value).

Dialogue Normalization serves to let you know if the source material has been recorded at a higher or lower level than usual. For example, if you see the following message: "D-NORM + 4 dB" on the FL display, to keep the overall output level constant just turn down the volume control by 4 dB. In other words, the source material that you are listening to has been recorded 4 dB louder than usual.

If you do not see a message on the FL display, then no adjustment of the volume control is necessary.

**VIDEO CONVERT**

**ANALOG VIDEO CONVERSION**

The SR6001 is equipped to convert video signals for monitor output. Because of this, indifferent of the connection (VIDEO, S-VIDEO, COMPONENT VIDEO) between the playback device and the SR6001, listening and viewing are possible with a single higher grade cable between the MONITOR OUT terminal of the SR6001 and the monitor.

**UP-CONVERSION FROM ANALOG VIDEO SIGNALS TO HDMI**

The up-conversion feature of the SR6001 can output the input analog video signals (for component video signals of 480i, 576i, 480p, 576p, 1080i and 720p resolution, and S-Video and Video (composite) of 480i, 576i resolution) to the HDMI MONITOR terminal.

**Notes:**

- HDMI video input is only output to the HDMI MONITOR OUT terminal of the SR6001. If connecting a playback device such as a DVD player to the HDMI input jack, connect the HDMI MONITOR OUT terminal of the SR6001 to a TV monitor.
- This mode is unavailable for the REC out terminal.
- This mode is unavailable for still picture, fast forward and reverse play on video component.
- If, while attempting to use the video convert feature, the SR6001 cannot synchronize with the display device, "NO SIGNAL" appears on the monitor or noise is generated, this feature cannot be used. All of these signs are caused by equipment incompatibility; there is nothing wrong with the SR6001. If this occurs, set "VIDEO CONVERT" in the "VIDEO SETUP" menu to "DISABLE". Next, connect the video input signal to the display component via the MONITOR OUT terminal under VIDEO and the S-video input signal to the display component via the MONITOR OUT terminal under S-VIDEO.
- The video convert feature constantly monitors input video signals and determines whether to convert the input signals or not. However, some input video signals cannot be detected correctly. If this occurs, set "VIDEO CONVERT" in the "VIDEO SETUP" menu to "DISABLE".

**CONNECTION EXAMPLE**

- When a monitor is connected to the HDMI MONITOR OUT terminal of the SR6001

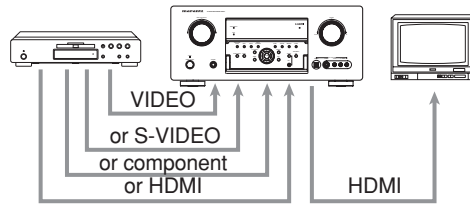

**Notes:**

- If the resolution of the component video signal input from the playback device is other than 480i, 576i, 480p, 576p, 1080i or 720p, images are not output from the HDMI MONITOR OUT terminal of the SR6001.
- If the resolution of the S-Video or Video signal input from the playback device is other than 480i, 576i, images are not output from the HDMI MONITOR OUT terminal of the SR6001.
- When a monitor is connected to the VIDEO or S-VIDEO MONITOR OUT terminals of the SR6001

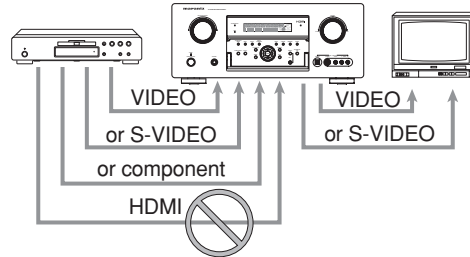

**Notes:**

- The HDMI video signal input from the playback device is not output from the VIDEO or S-VIDEO MONITOR OUT terminals of the SR6001.
- If the resolution of the component video signal input from the playback device is other than 480i, 576i, it is not output from the VIDEO or S-VIDEO MONITOR OUT terminals of the SR6001.

- When a monitor is connected to the COMPONENT VIDEO MONITOR OUT terminal of the SR6001

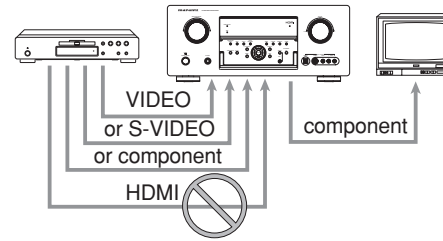

**Notes:**

- The HDMI video signal input from the playback device is not output from the COMPONENT VIDEO MONITOR OUT terminal of the SR6001.

**Notes of OSD menu system:**

- The setup menu can be displayed through all video out terminals ("HDMI", "COMPONENT", "SVIDEO" and "VIDEO").
  - OSD information is output only to the VIDEO and S-VIDEO MONITOR OUT terminals.
- OSD information is also output when the video conversion feature is on and the video signal input to the VIDEO or S-VIDEO input jack of the SR6001 is converted and output from the COMPONENT VIDEO or HDMI MONITOR OUT terminals.

**I/P CONVERT**

The video circuit of the SR6001 is equipped with an I/P conversion feature. When this feature is on, 480i, 576i analog video signals (VIDEO, S-VIDEO or COMPONENT VIDEO) input from a playback device can be converted to 480p, 576p and progressively output to the COMPONENT VIDEO or HDMI MONITOR OUT terminals of the SR6001. (For setting instructions, see page 38)

**TEMPORARILY TURNING OFF THE SOUND**

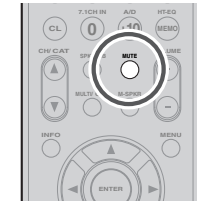

To temporarily silence all speaker outputs such as when interrupted by a phone call, press the **MUTE** button on the remote. This will interrupt the output to all speakers and the head-phone jack, but it will not affect any recording or dubbing that may be in progress. When the system is muted, the display will show "MUTE". Press the **MUTE** button again to return to normal operation.

**USING THE SLEEP TIMER**



To program the SR6001 for automatic standby, press the **SLEEP** button on the remote. Each press of the button will increase the time before shut down in the following sequence.

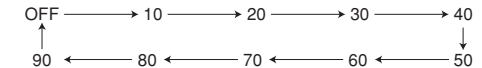

The sleep time will be shown for a few seconds in the display on the front panel, and it will count down until the time has elapsed. When the programmed sleep time has elapsed, the unit will automatically turn off. Note that the SLEEP indicator on the display will illuminate when the Sleep function is programmed. To cancel the Sleep function, press the **SLEEP** button until the display shows "SLEEP OFF" and the SLEEP indicator will disappear.

# SURROUND MODE

## SURROUND

The SR6001 is equipped with many surround modes. These are provided to reproduce a variety of surround sound effects, according to the content of the source to be played.

The available surround modes may be restricted depending on the input signal and speaker setup.

## SOURCE DIRECT

In the Source Direct mode, the tone control circuit Acoustic EQ, and bass management configuration are bypassed for full-range frequency response and the purist audio reproduction.

### Notes:

- Speaker size is set to Front L/R = LARGE, Center = LARGE, Surround L/R = LARGE and Subwoofer = YES automatically. Tone controls, equalizer and additional processing are deactivated.
- When you use this mode with certain DVD and CD players, performing operations such as skip or stop may momentarily interrupt the output.

## PURE DIRECT

The Pure Direct mode further reduces sources of noise in addition to effect of the Source Direct mode, by blocking output from the video jacks (VIDEO, S-VIDEO, COMPONENT VIDEO and HDMI) and turning the FL display off.

## AUTO

When this mode is selected, the SR6001 determines whether the digital input signal is Dolby Digital, Dolby Digital Surround EX, DTS, DTS-ES, DTS 96/24 or PCM audio.

Surround EX & DTS-ES will operate for multichannel sources that have a Dolby Digital Surround EX or DTS-ES auto trigger flag in the digital signal.

When a Dolby Digital or DTS signal is input, the number of channels for which the corresponding signal is encoded will be played.

Inputting a Dolby Digital two channel signal with Dolby surround status automatically subjects that signal to Pro Logic IIx movie processing before play. PCM 96 kHz source material can be played in this mode.

### Notes:

- When you use this mode with certain DVD and CD players, performing operations such as skip or stop may momentarily interrupt the output.
- When the signal is not decoded, the mode is changed to AUTO mode automatically. See page 47 to confirm the available decoding modes.

## DCI MODE

### (Dolby Digital, Pro Logic IIx MOVIE, Pro Logic IIx MUSIC, Pro Logic IIx GAME)

This mode is used with source materials encoded in Dolby Digital and Dolby Surround.

## DOLBY DIGITAL

This mode is enabled when playing source materials encoded in Dolby Digital.

Playing multichannel-encoded 5.1 channel Dolby Digital sources provides 5 main audio channels (left, center, right, surround left and surround right) and a Low Frequency Effect channel.

Dolby Digital EX decoding is not available in this mode.

Dolby Pro Logic IIx has 5 modes:

### Pro Logic IIx MOVIE

This mode provides 6.1 or 7.1 channel surround sound from Dolby Surround, encoded stereo movie soundtracks.

### Pro Logic IIx MUSIC

This mode provides 6.1 or 7.1 channel surround sound from conventional stereo sources (analog or digital), such as CD, tape, FM, TV, stereo VCR, etc.

### Pro Logic IIx GAME

This mode restores the impact low-frequency surround effects by routing them to the system's subwoofer.

### 5.1ch + Pro Logic IIx Movie

This mode provides 7.1 channel surround sound from 5.1 channel sources movie soundtracks.

### 5.1ch + Pro Logic IIx Music

This mode provides 6.1 or 7.1 channel surround sound from 5.1 channel sources music soundtracks.

### Notes:

- Pro Logic IIx mode will decode as Pro Logic II mode when the SURR. B is set to "NONE" from SPEAKER SETUP menu. (See page 34)
- Pro Logic IIx mode is available for a 2 channel input signal which is encoded in Dolby Digital, HDCD or PCM format.

## EX/ES

This mode provides 6.1 channel surround for Dolby Digital EX, and DTS-ES-encoded source material such as DVD.

This mode cannot be used when an analog input has been selected.

## Dolby Digital EX

In a movie theater, film soundtracks that have been encoded with Dolby Digital Surround EX technology are able to reproduce an extra channel which has been added during the mixing of the program.

This channel, called surround back, places sounds behind the listener in addition to the currently available front left, front center, front right, surround right, surround left and subwoofer channels.

This additional channel provides the opportunity for more detailed imaging behind the listener and brings more depth, spacious ambience and sound localization than ever before.

Dolby Digital EX is not available in systems that do not have without surround back speaker(s).

## DTS-ES (Discrete 6.1, Matrix 6.1)

DTS-ES adds the surround center channel audio to the DTS 5.1 channel format to improve the acoustic positioning, and makes acoustic image movement more natural with the 6.1 channel reproduction.

The SR6001 incorporates a DTS-ES-decoder, which can handle DTS-ES Discrete-encoded and DTS-ES Matrix-encoded program sources from DVD, etc.

DTS-ES Discrete 6.1 features digital discrete recording of all channels, including the surround back channel(s), and higher quality audio reproduction.

DTS-ES is not available in systems that do not have surround back speakers.

## dts

dts, Neo:6 Cinema, Neo:6 Music

This mode is for DTS-encoded source materials such as laserdisc, CD and DVD. Neo:6 is for some 2 channel sources.

## dts

This mode is enabled when playing source materials encoded in dts multichannel.

Playing multichannel encoded-5.1 channel dts sources provides five main audio channels (left, center, right, surround left and surround right) and a Low Frequency Effects channel.

dts-ES decoding is not available in this mode.

The DTS mode cannot be used when an analog input has been selected.

**Neo:6 Cinema, Neo:6 Music**

This mode decodes 2 channel signals into 6 channel signals using high-accuracy digital matrix technology. The DTS Neo:6 decoder has near-discrete properties in the frequency characteristics of the channels as well as in channel separation.

According to the signals to be played back, DTS Neo:6 uses either the Neo:6 Cinema mode optimized for movie playback or the Neo:6 Music mode optimized for music playback.

**Note:**

- The Neo:6 mode is available for 2 channel input signals which are encoded in Dolby Digital, HDCD or PCM format.

**MULTI CH. (MOVIE, MUSIC)**

This mode is used to create a wider, deeper and more natural soundstage from two channel source material. This is done by feeding the left channel signal to both the left front and left surround speakers and the right channel signal to both the right front and right surround speakers. Additionally, the center channel reproduces a mix of the right and left channels.

**CIRCLE SURROUND II****(CSII-CINEMA, CSII-MUSIC, CSII-MONO)**

Circle Surround is designed to enable multichannel surround sound playback of non-encoded and multichannel encoded material.

Backward compatibility provides listeners with up to 6.1 channels of surround performance from an entire collection of music and film, including broadcast, videotape and stereo recorded music.

Depending on source material, you can select CSII-Cinema mode, CSII-Music mode or CSII-Mono mode.

**Note:**

- The CS II mode is available for 2 channel input signals which are encoded in Dolby Digital, HDCD or PCM format.

**Dolby Virtual Speaker**

Dolby Virtual Speaker technology uses proprietary technology of Dolby Laboratories to create a virtual surround sound field using only two speakers for the front channels, allowing the user to experience sound as if surround speakers were actually being used.

**STEREO**

This mode bypasses all surround processing.

In stereo program sources, the left and right channels play normally when PCM audio or analog stereo is input.

With Dolby Digital and DTS sources, the 5.1 channels are converted to two channel stereo. 96 kHz PCM source material can be played back in stereo mode.

**CAUTION****Notes for DTS**

- To connected DVD player, laserdisc player or CD player needs to support DTS digital output. You may not be able to play some DTS source signals from certain CD players and LD players even if you connect the player to the SR6001 digitally. This is because the digital signal has been processed (such as the output level, sampling frequency or frequency response), and the SR6001 cannot recognize the signal as DTS data.
- Depending on the player used, DTS play may produce a short noise. This is not a malfunction.
- While signals from a DTS laserdisc or CD are playing in another surround mode, you cannot switch to digital input or from digital input to analog input from the INPUT SETUP in the MAIN MENU or by pressing the **A/D** button.
- You can not listen to DTS-encoded software in a multiroom.
- The outputs for VCR OUT, TAPE OUT and CD-R OUT output analog audio signals only. Do not record from CDs or LDs that support DTS using these outputs. If you do, the DTS-encoded signal will be recorded as noise.

**Notes or Dolby Digital Surround EX**

- When playing Dolby Digital Surround EX-encoded software in 6.1 channels, it is required to set the EX/ES mode.
- Note that some Dolby Digital Surround EX-encoded software does not contain the identification signal. In this case, set the EX/ES mode manually.

**Notes for 96 kHz/192 kHz PCM audio**

- The AUTO, Pure Direct, and Stereo modes can be used when playing PCM signals with a sampling frequency of 96/192 kHz (such as from DVD-Video/Audio discs).
- Certain DVD player models inhibit digital output. For details, refer to the player's operation manual.
- Some DVD discs feature copy protection. When using such disc, 96 kHz PCM signal are not output from the DVD player. For details, refer to the player's operation manual.

**Notes for HDCD**

- HDCD is effective only through digital input.
- You may not be able to play some HDCD source signals from certain CD players if you connect the player to the SR6001 digitally. This is because the digital signal has been processed (such as the output level, sampling frequency or frequency response) and the SR6001 cannot recognize the signal as HDCD data.



**The relationship between the selected surround mode and the input signal**

The surround mode is selected with the surround mode selector on the SR6001 or the remote control unit. However, the sound you hear is subject to the relationship between the selected surround mode and the input signal. That relationship is as follows:

Surround Mode	Input Signal	Decoding	Output Channel					Front information display	
			L/R	C	SL SR	SBL SBR	SubW	Signal format indicators	Channel status
AUTO	Dolby Surr.EX	Dolby Digital EX	○	○	○	○	○	DD DIGITAL EX	L C R SL SR S LFE
	Dolby D (5.1ch)	Dolby Digital 5.1	○	○	○	-	○	DD DIGITAL	L C R SL SR LFE
	Dolby D (2ch)	Dolby Digital 2.0	○	-	-	-	○	DD DIGITAL	L R
	Dolby D (2ch Surr)	Pro Logic IIx movie	○	○	○	○	○	DD DIGITAL DD SURROUND	L R S
	DTS-ES	DTS-ES	○	○	○	○	○	dtS ES	L C R SL SR S LFE
	DTS 96/24	DTS 96/24	○	○	○	-	○	dtS 96/24	L C R SL SR LFE
	DTS (5.1ch)	DTS 5.1	○	○	○	-	○	dtS	L C R SL SR LFE
	Multi Ch-PCM	Multi Ch-PCM	○	○	○	-	○	PCM	L C R SL SR LFE
	Multi Ch-PCM 96kHz	Multi Ch-PCM 96kHz	○	○	○	-	○	PCM	L C R SL SR LFE
	DSD (5.1ch)	Multi Ch-PCM	○	○	○	-	○	DSD	L C R SL SR LFE
	DSD (2ch)	PCM (Stereo)	○	-	-	-	○	DSD	L R
	PCM (Audio)	PCM (Stereo)	○	-	-	-	○	PCM	L R
	PCM 96kHz	PCM (Stereo 96kHz)	○	-	-	-	○	PCM	L R
	HDCD	HDCD	○	-	-	-	○	PCM, HDCD	L R
	Analog	Stereo	○	-	-	-	○	ANALOG	-
	7.1ch input	Multi Ch	○	○	○	○	○	ANALOG	-
	SOURCE DIRECT PURE DIRECT	Dolby Surr.EX	Dolby Digital EX	○	○	○	○	○	DD DIGITAL EX
Dolby D (5.1ch)		Dolby Digital 5.1	○	○	○	-	○	DD DIGITAL	L C R SL SR LFE
Dolby D (2ch)		Dolby Digital 2.0	○	-	-	-	○	DD DIGITAL	L R
Dolby D (2ch Surr)		Pro Logic IIx movie	○	○	○	○	○	DD DIGITAL DD SURROUND	L R S
DTS-ES		DTS-ES	○	○	○	○	○	dtS ES	L C R SL SR S LFE
DTS 96/24		DTS 96/24	○	○	○	-	○	dtS 96/24	L C R SL SR LFE
DTS (5.1ch)		DTS 5.1	○	○	○	-	○	dtS	L C R SL SR LFE
Multi Ch-PCM		Multi Ch-PCM	○	○	○	-	○	PCM	L C R SL SR LFE
Multi Ch-PCM 96kHz		Multi Ch-PCM 96kHz	○	○	○	-	○	PCM	L C R SL SR LFE
DSD (5.1ch)		DSD (5.1ch)	○	○	○	-	○	DSD	L C R SL SR LFE
DSD (2ch)		DSD (2ch)	○	-	-	-	○	DSD	L R
PCM (Audio)		PCM (Stereo)	○	-	-	-	○	PCM	L R
PCM 96kHz		PCM (Stereo 96kHz)	○	-	-	-	○	PCM	L R
HDCD		HDCD	○	-	-	-	○	PCM, HDCD	L R
Analog		Stereo	○	-	-	-	○	ANALOG	-
7.1ch input		Multi Ch	○	○	○	○	○	ANALOG	-
EX/ES		Dolby Surr.EX	Dolby Digital EX	○	○	○	○	○	DD DIGITAL EX
	Dolby D (5.1ch)	Dolby Digital EX	○	○	○	○	○	DD DIGITAL	L C R SL SR LFE
	DTS-ES	DTS-ES	○	○	○	○	○	dtS ES	L C R SL SR S LFE
	DTS (5.1ch)	DTS-ES	○	○	○	○	○	dtS	L C R SL SR LFE
	Multi-PCM	Multi Ch-PCM + Dolby Digital EX	○	○	○	○	○	PCM	L C R SL SR LFE
	DSD (5.1ch)	Multi Ch-PCM + Dolby Digital EX	○	○	○	○	○	DSD	L C R SL SR LFE
DOLBY (PLIIx movie) (PLIIx music) (PLIIx game)	Dolby Surr.EX	Dolby Digital EX	○	○	○	-	○	DD DIGITAL EX	L C R SL SR S LFE
	Dolby D (5.1ch)	Dolby Digital 5.1	○	○	○	-	○	DD DIGITAL	L C R SL SR LFE
	Dolby D (5.1ch)	Dolby Digital 5.1 + PLIIx	○	○	○	○	○	DD DIGITAL	L C R SL SR LFE
	Dolby D (2ch)	Pro Logic IIx	○	○	○	○	○	DD DIGITAL	L R
	Dolby D (2ch Surr)	Pro Logic IIx	○	○	○	○	○	DD DIGITAL DD SURROUND	L R S
	Multi Ch-PCM	Multi Ch-PCM + PLIIx	○	○	○	○	○	PCM	L C R SL SR LFE
	DSD (5.1ch)	Multi Ch-PCM + PLIIx	○	○	○	○	○	DSD	L C R SL SR LFE
	DSD (2ch)	Pro Logic IIx	○	○	○	○	○	DSD	L R
	PCM (Audio)	Pro Logic IIx	○	○	○	○	○	PCM	L R
	HDCD	Pro Logic IIx	○	○	○	○	○	PCM, HDCD	L R
Analog	Pro Logic IIx	○	○	○	○	○	ANALOG	-	
DTS (Neo:6 Cinema) (Neo:6 Music)	DTS-ES	DTS 5.1	○	○	○	-	○	dtS ES	L C R SL SR S LFE
	DTS 96/24	DTS 96/24	○	○	○	-	○	dtS 96/24	L C R SL SR LFE
	DTS (5.1ch)	DTS 5.1	○	○	○	-	○	dtS	L C R SL SR LFE
	Dolby D (2ch)	Neo:6	○	○	○	○	○	DD DIGITAL	L R
	Dolby D (2ch Surr)	Neo:6	○	○	○	○	○	DD DIGITAL DD SURROUND	L R S
	DSD (2ch)	Neo:6	○	○	○	○	○	DSD	L R
	PCM(Audio)	Neo:6	○	○	○	○	○	PCM	L R
	HDCD	Neo:6	○	○	○	○	○	PCM, HDCD	L R
Analog	Neo:6	○	○	○	○	○	ANALOG	-	
CSII Cinema CSII Music CSII Mono	Dolby D (2ch)	CSII	○	○	○	○	○	DD DIGITAL	L R
	Dolby D (2ch Surr)	CSII	○	○	○	○	○	DD DIGITAL DD SURROUND	L R S
	DSD (2ch)	CSII	○	○	○	○	○	DSD	L R
	PCM(Audio)	CSII	○	○	○	○	○	PCM	L R
	HDCD	CSII	○	○	○	○	○	PCM, HDCD	L R
	Analog	CSII	○	○	○	○	○	ANALOG	-
STEREO	Dolby Surr.EX	Stereo	○	-	-	-	○	DD DIGITAL EX	L C R SL SR S LFE
	Dolby D (5.1ch)	Stereo	○	-	-	-	○	DD DIGITAL	L C R SL SR LFE
	Dolby D (2ch)	Stereo	○	-	-	-	○	DD DIGITAL	L R
	Dolby D (2ch Surr)	Stereo	○	-	-	-	○	DD DIGITAL DD SURROUND	L R S
	DTS-ES	Stereo	○	-	-	-	○	dtS ES	L C R SL SR S LFE
	DTS 96/24	Stereo	○	-	-	-	○	dtS 96/24	L C R SL SR LFE
	DTS (5.1ch)	Stereo	○	-	-	-	○	dtS	L C R SL SR LFE
	Multi Ch-PCM	Stereo	○	-	-	-	○	PCM	L C R SL SR LFE
	Multi Ch-PCM 96kHz	Stereo	○	-	-	-	○	PCM	L C R SL SR LFE
	DSD (5.1ch)	Stereo	○	-	-	-	○	DSD	L C R SL SR LFE
	DSD (2ch)	Stereo	○	-	-	-	○	DSD	L R
	PCM (Audio)	Stereo	○	-	-	-	○	PCM	L R
	PCM 96kHz	Stereo	○	-	-	-	○	PCM	L R
	HDCD	Stereo	○	-	-	-	○	PCM, HDCD	L R
Analog	Stereo	○	-	-	-	○	ANALOG	-	



Surround Mode	Input Signal	Decoding	Output Channel					Front information display	
			L/R	C	SL SR	SBL SBR	SubW	Signal format indicators	Channel status
Dolby Virtual Speaker	Dolby Surr.EX	Dolby Virtual Speaker	○	-	-	-	-	□□ DIGITAL EX	L, C, R, SL, SR, S, LFE
	Dolby D (5.1ch)	Dolby Virtual Speaker	○	-	-	-	-	□□ DIGITAL	L, C, R, SL, SR, LFE
	Dolby D (2ch)	Dolby Virtual Speaker	○	-	-	-	-	□□ DIGITAL	L, R
	Dolby D (2ch Surr)	Dolby Virtual Speaker	○	-	-	-	-	□□ DIGITAL □□ SURROUND	L, R, S
	DTS-ES	Dolby Virtual Speaker	○	-	-	-	-	dtS, ES	L, C, R, SL, SR, S, LFE
	DTS 96/24	Dolby Virtual Speaker	○	-	-	-	-	dtS 96/24	L, C, R, SL, SR, LFE
	DTS (5.1ch)	Dolby Virtual Speaker	○	-	-	-	-	dtS	L, C, R, SL, SR, LFE
	Multi Ch-PCM	Dolby Virtual Speaker	○	-	-	-	-	PCM	L, C, R, SL, SR, LFE
	DSD (5.1ch)	Dolby Virtual Speaker	○	-	-	-	-	DSD	L, C, R, SL, SR, LFE
	DSD (2ch)	Dolby Virtual Speaker	○	-	-	-	-	DSD	L, R
	PCM (Audio)	Dolby Virtual Speaker	○	-	-	-	-	PCM	L, R
	HDCCD	Dolby Virtual Speaker	○	-	-	-	-	PCM, HDCCD	L, R
	Analog	Dolby Virtual Speaker	○	-	-	-	-	ANALOG	-
	Multi Ch. Movie Music	Dolby Surr.EX	Dolby Digital EX	○	○	○	○	○	□□ DIGITAL EX
Dolby D (5.1ch)		Dolby Digital 5.1	○	○	○	-	○	□□ DIGITAL	L, C, R, SL, SR, LFE
Dolby D (2ch)		Multi Channel	○	○	○	○	○	□□ DIGITAL	L, R
Dolby D (2ch Surr)		Multi Channel	○	○	○	○	○	□□ DIGITAL □□ SURROUND	L, R, S
DTS-ES		DTS-ES	○	○	○	○	○	dtS, ES	L, C, R, SL, SR, S, LFE
DTS 96/24		DTS-96/24	○	○	○	-	○	dtS 96/24	L, C, R, SL, SR, LFE
DTS (5.1ch)		DTS 5.1	○	○	○	-	○	dtS	L, C, R, SL, SR, LFE
Multi Ch-PCM		Multi Ch-PCM	○	○	○	-	○	PCM	L, C, R, SL, SR, LFE
Multi Ch-PCM 96kHz		Multi Ch-PCM 96kHz	○	○	○	-	○	PCM	L, C, R, SL, SR, LFE
DSD (5.1ch)		Multi Ch-PCM	○	○	○	-	○	DSD	L, C, R, SL, SR, LFE
DSD (2ch)		Multi Channel	○	○	○	○	○	DSD	L, R
PCM (Audio)		Multi Channel	○	○	○	○	○	PCM	L, R
HDCCD		Multi Channel	○	○	○	○	○	PCM, HDCCD	L, R
Analog		Multi Channel	○	○	○	○	○	ANALOG	-
Dolby H.P	Dolby Surr.EX	Dolby H.P	○	-	-	-	-	□□ DIGITAL EX	L, C, R, SL, SR, S, LFE
	Dolby D (5.1ch)	Dolby H.P	○	-	-	-	-	□□ DIGITAL	L, C, R, SL, SR, LFE
	Dolby D (2ch)	Dolby H.P	○	-	-	-	-	□□ DIGITAL	L, R
	Dolby D (2ch Surr)	Dolby H.P	○	-	-	-	-	□□ DIGITAL □□ SURROUND	L, R, S
	DTS-ES	Dolby H.P	○	-	-	-	-	dtS, ES	L, C, R, SL, SR, S, LFE
	DTS 96/24	Dolby H.P	○	-	-	-	-	dtS 96/24	L, C, R, SL, SR, LFE
	DTS (5.1ch)	Dolby H.P	○	-	-	-	-	dtS	L, C, R, SL, SR, LFE
	Multi Ch-PCM	Dolby H.P	○	-	-	-	-	PCM	L, C, R, SL, SR, LFE
	DSD (5.1ch)	Dolby H.P	○	-	-	-	-	DSD	L, C, R, SL, SR, LFE
	DSD (2ch)	Dolby H.P	○	-	-	-	-	DSD	L, R
	PCM (Audio)	Dolby H.P	○	-	-	-	-	PCM	L, R
	HDCCD	Dolby H.P	○	-	-	-	-	PCM, HDCCD	L, R
	Analog	Dolby H.P	○	-	-	-	-	ANALOG	-

**Notes:**

- Dolby Digital (2 channel L/R): Speakers for signal with Dolby Surround are fully equipped.
- No sound is outputs from the surround speaker, center speaker and subwoofer if the DVD disc has no surround data.

Abbreviations

- L/R : Front speakers
- C : Center speaker
- SL/SR : Surround speakers
- SBL/SBR : Surround back speakers
- SubW : Subwoofer

# OTHER FUNCTION

## TV AUTO ON/OFF FUNCTION

This function allows the component connected to the TV-VIDEO in jack to control the power (ON/OFF) to the SR6001.

### AUTO POWER ON

1. Be sure the TV auto mode is ENABLED. (Refer to page 38: PREFERENCE)
2. Connect your TV TUNER (etc) to the TV-VIDEO in terminal. Be sure to connect the VIDEO input.
3. Turn OFF the power to the TV TUNER and the SR6001.
4. Turn ON the TV TUNER and tune in a receivable station.
5. When the station is received, the SR6001 turns ON and TV is selected automatically.

### AUTO POWER OFF

1. In the above situation, turn the TV TUNER OFF or select a channel that does not contain any broadcast.
2. The power to the SR6001 switches to STANDBY after approx. 5 minutes.

#### Notes:

- AUTO POWER OFF is canceled if the SR6001 is set to a source other than TV. The function reactivates when TV is selected again.
- Some TV broadcasts may cause the TV AUTO FUNCTION to turn ON.
- The S-Video terminal does not support "TV AUTO ON/OFF" function.

## ATTENUATION TO ANALOG INPUT SIGNAL



If the selected analog audio input signal is greater than the capable level of internal processing, the "PEAK" indicator will light up on the front display. If this happens, you should press the **ATT** button on the remote. "ATT" indicator will be illuminated when this function is activated. The signal-input level is reduced by about half. Attenuation will not work with the output signal of TAPE-OUT, CD/CD-R and VCR OUT. This function is memorized for each individual input source.

## LISTENING THROUGH HEADPHONES

This jack may be used to listen to the SR6001's output through a pair of headphones. Be certain that the headphones have a standard 1/4" stereo phono plug. (Note that the speakers will automatically be turned off when the headphone jack is in use.)

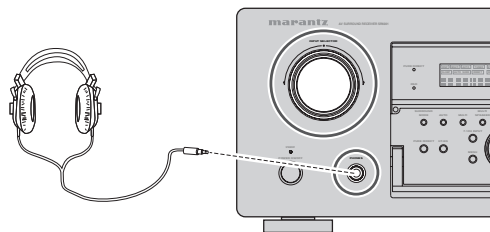

#### Note:

- The surround mode returns to the previous setting as soon as the plug is removed from the jack.

## DOLBY HEADPHONE MODE

This feature simulates the waveforms of the actual sounds heard from the speakers. When headphones are used, the **MENU** button automatically switches to the Dolby headphone mode.

The OSD that appears when the **MENU** button is pressed is shown below.

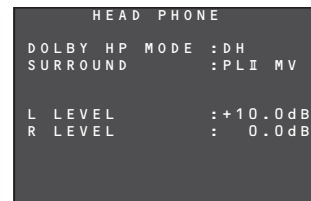

DOLBY HP (Headphone) MODE can be selected with the left and right cursor buttons. BYPASS → DH (DOLBY Headphone) → BYPASS

**BYPASS:** Bypasses the Dolby headphone mode and delivers ordinary 2-channel stereo.

**DH:** Dolby Headphone is a signal processing system that delivers a sound similar to room speakers.

It makes it possible to experience the volume and space of a 5-channel surround system using ordinary stereo headphones.

When the PURE DIRECT mode is selected, Dolby surround processing is bypassed and "\*\*\*" is displayed as the mode indication.

The surround mode can be selected when the modes in DH is selected.

L/R LEVEL can be set in the ±12 dB range.

#### Notes:

- The surround mode returns to the previous setting as soon as the plug is removed from the jack.
- TONE and ACOUSTIC EQ cannot be set when the DH mode is selected.

## VIDEO ON/OFF

When no video signal is connected to the SR6001 or a DVD, etc., is connected directly to your TV, the unnecessary video circuit can be turned off by selecting the "VIDEO OFF" setting.

To select video off, press the **AMP** button and press the **V-OFF** button.

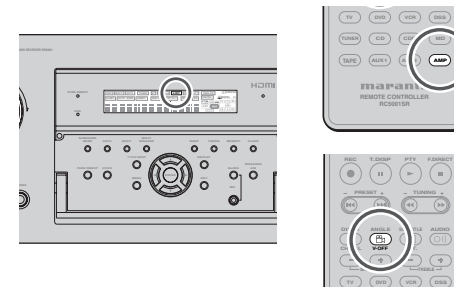

## DISPLAY MODE

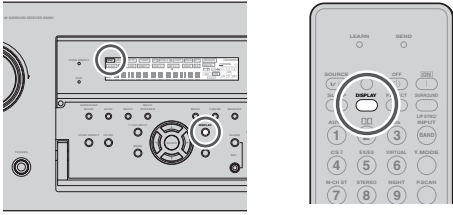

You can select the display mode for the front display of the SR6001.

To select this mode, press the **DISPLAY** on the remote control or the front panel.

When this button is pressed, the display mode is switched in the following sequence.

Input Mode → Surround Mode → Auto display OFF → Display OFF → Normal Mode → Input Mode

**Normal Mode:**

Displays the selected input function. If the function has been renamed using the Function Rename feature (see page 29), the renamed name appears on the display.

**Input Mode:**

Displays the input mode set via the Function Input Setup feature (see page 28).

**Surround Mode:**

Displays the status of the selected surround mode.

**Auto Display Off mode:**

The display is off. But, if you make a change to the unit such as the input or surround mode, the display will show that change, then go back to off after about 3 seconds. When changing the volume, it is not displayed.

**Display Off mode:**

The display is off completely.

**Note:**

- Only the DISP indicator will be illuminated on the front display in display off condition.

## SELECTING ANALOG AUDIO INPUT OR DIGITAL AUDIO INPUT



If you have already assigned the digital inputs, you can temporarily select the audio input mode for each input source as following procedures.

Press the **AMP** button first to enter the AMP mode then press the **A/D** button.

When this button is pressed, the input mode is switched in the following sequence.

Auto → HDMI → Digital → Analog → Auto

**Auto mode:**

The types of signals being input to the digital and analog input jacks for the selected input source are detected automatically.

If no digital signal is being input, the analog input jacks are selected automatically.

**HDMI mode:**

HDMI mode can be selected only when an HDMI input has been assigned as an input source.

When "HDMI AUDIO" under PREFERENCE of the SETUP MENU is set to "THROUGH", the HDMI mode cannot be selected.

**Digital mode:**

The input signal is fixed to an assigned digital input terminal.

**Analog mode:**

The analog input jacks are selected.

This selection is temporary and will not be stored in memory.

To store changes to the input mode, select "**1. INPUT SETUP**" from the MAIN MENU. (See page 28)

## RECORDING AN ANALOG SOURCE

In normal operation, the audio or video source selected for listening through the SR6001 is sent to the record outputs.

This means that any program you are watching or listening to may be recorded simply by placing machines connected to the outputs for **TAPE OUT**, **CD/CDR OUT** and **VCR OUT** in the record mode.

*To record the input source signal you are currently watching or listening to*

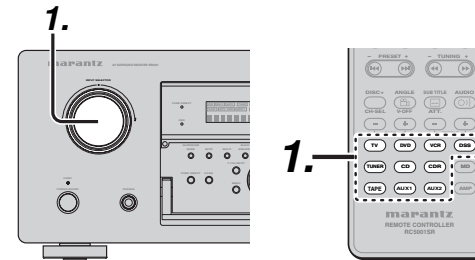

1. Select the input source to record by turning the **INPUT FUNCTION SELECTOR** knob on the front panel or simply press the input selector buttons on the remote.  
The input source is now selected and you may watch or listen to it as desired.
2. The currently selected input source signal is output to the **TAPE OUT**, **CD/CDR OUT** and **VCR OUT** outputs for recording.
3. Start recording to the recording component as desired.

## SPEAKER A/B

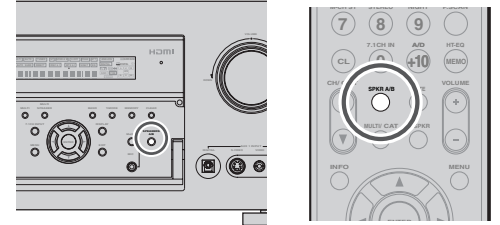

SR6001 has speaker system - A and speaker system- B for front L/R channels.

You can select these systems by pressing **SPEAKERS A/B** button on the front panel or **SPKR A/B** on the remote.

### 7.1 CH INPUT

The SR6001 is equipped for future expansion through the use of Multi channel Super Audio CD multichannel player or DVD-Audio player.

When this is selected, the input signals connected to the L(front left), R (front right), CENTER, SL (surround left), SR (surround right) and SBL (surround back left) and SBR (surround back right) channels of the 7.1 CH. In jacks are output directly to the front (left and right), center, surround (left and right) and surround back speaker systems as well as the pre-out jacks without passing through the surround circuitry.

In addition, the signal input to the SW (subwoofer) jack is output to the PRE OUT SW (subwoofer) jack. When 7.1 CH. INPUT is selected, the last video input used remains routed to the **Monitor Outputs**.

This permits simultaneous viewing with video sources

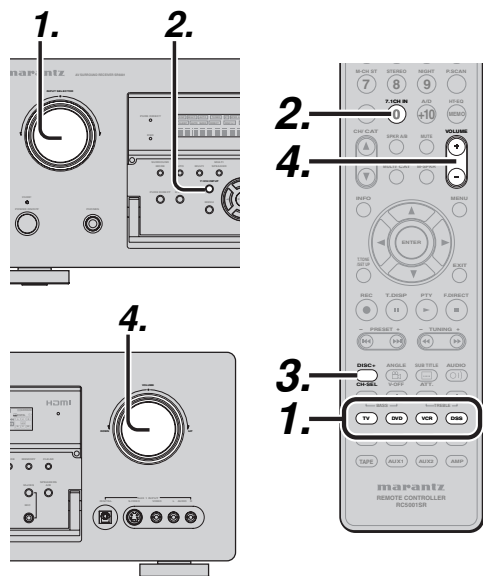

1. Select a desired Video source to decide the routed video signal to the **Monitor Outputs**.
2. Press the **7.1 CH INPUT** button on the front panel or press **7.1 CH** on the remote to switch the 7.1 channel input.
3. If it is necessary to adjust the output level of each channel, press the **CH-SEL** button on the remote.  
  
Adjust the speaker output levels so that you can hear the same sound level from each speaker at the listening position. For the front left, front right, center, surround left, surround right and surround back speakers, the output levels can be adjusted between -12 to +12 dB.  
  
The subwoofer can be adjusted between -18 and +12 dB.  
  
These adjustments result will be stored to 7.1 CH. INPUT memory.
4. Adjust the main volume with the **MAIN VOLUME** knob or the **VOL** buttons on the remote.

To cancel the 7.1 CH. INPUT setting, press the **7.1 CH INPUT** button on the front panel or press **7.1 CH** on the remote.

**Notes:**

- When the 7.1 CH. Input is in use, you may not select a surround mode, as the external decoder determines processing.
- In addition, there is no signal at the record outputs when the 7.1 CH. Input is in use.

### AUX2 INPUT

If you don't need to connect 7.1 Ch. input terminals with multi channel decoder, L(front left) and R (front right) inputs terminals are available as AUX2 input.

In this case, You can connect additional audio source to AUX2 as other audio input terminals.

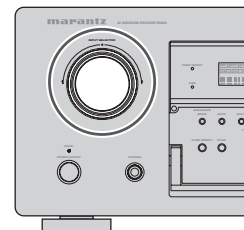

### LIP.SYNC

Depending on the image device (TV, monitor, projector, etc.) connected to the SR6001, a time lag can occur between image signal processing and audio signal processing. Though minor, this time lag can interfere with movie and music enjoyment. The LIP.SYNC feature delays the audio signal with respect to the image signal output from the SR6001 to correct the time lag between the sound and image. It can be operated with the "**LIP SYNC**" and **◀** and **▶** cursor buttons of the remote controller. Set the remote controller to the AMP mode before operating the LIP.SYNC feature. The initial setting is OFF (0 ms). The time lag can be adjusted in 10 ms steps up to 200 ms.

Watch the picture on the image device (i.e., TV, monitor, projector, etc.) as you adjust the time lag.

**Note:**

- The LIP.SYSNC feature turns OFF (0 ms) in the SOURCE/PURE DIRECT mode. When the SOURCE/PURE DIRECT mode is deactivated, the set value of the LIP.SYSNC feature is automatically restored.



# BASIC OPERATION

## (TUNER)

To operate the unit from the remote control, press the **TUNER** button on the remote control so that the tuner mode is engaged.

### LISTENING TO THE TUNER

Frequency scan step for AM is selectable. Default setup is 10 kHz step, if your country's standard is 9 kHz step, Press **BAND** button on the front panel or **TUNER** button on the remote more than 5 seconds. Scan step will change.

#### Note:

- Preset memory for the tuner will clear by changing this setup.

### AUTO TUNING

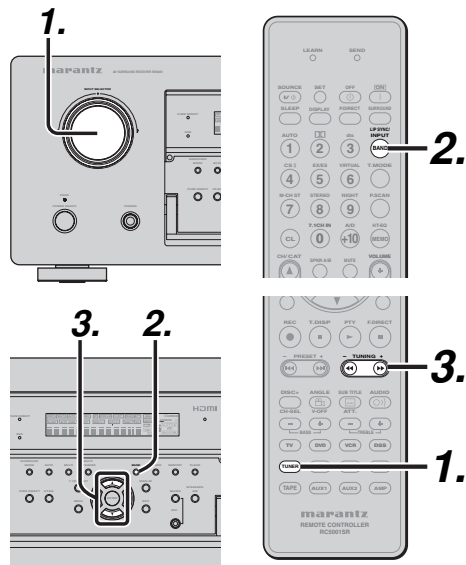

### (Using the SR6001)

1. Turn the INPUT SELECTOR knob to select "TUNER".
2. Press the **BAND** button to select either FM or AM.
3. Press the **▲** or **▼** cursor buttons on the front Panel for more than 1 second to start the auto tuning function.
4. Automatic searching begins then stops when a station is tuned in.

### (Using the remote control unit)

1. To select tuner, Press the **TUNER** button twice within two second on the remote.
2. Press the **BAND** button to select either FM or AM.
3. Press and hold the **TUNING +** or **-** button for 1 second or more.
4. Automatic searching begins then stops when a station is tuned in.

If tuning does not stop at the desired station, use to the "Manualtunin" operation.

### MANUAL TUNING

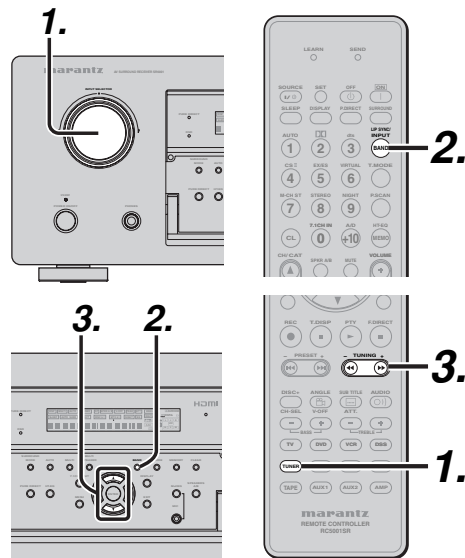

### (Using the SR6001)

1. Turn the INPUT SELECTOR knob to select "TUNER".
2. Press the **BAND** button to select either FM or AM.
3. Press the **▲** or **▼** cursor buttons on the front Panel to select the desired station.

### (Using the remote control unit)

1. To select tuner, press the **TUNER** button twice within two seconds on the remote.
2. Press the **BAND** button to select either FM or AM.
3. Press the **TUNING +** or **-** button to tune in the deseired station.

### DIRECT FREQUENCY CALL

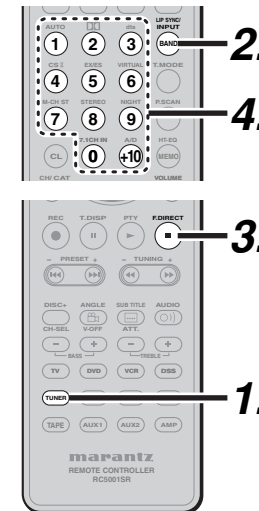

1. To select tuner, Press the **TUNER** button twice within two seconds on the remote.
2. Press the **BAND** button to select either FM or AM.
3. Press the **F.DIRECT** on the remote, display will show "FREQ----".
4. Input your desired station's, frequency with the ten numbered keypad on the remote.
5. The desired station will automatically be tuned.

### (FM) TUNING MODE (AUTO STEREO OR MONO)

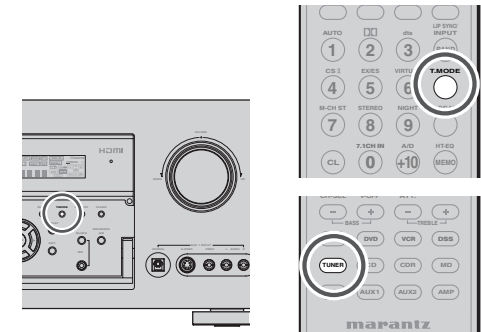

When in the auto stereo mode, **AUTO** indicator will be illuminated on the display.

The "**ST**" indicator is illuminated when a stereo broadcast is tuned in.

At open frequencies, the noise is muted and the "**TUNED**" and "**ST**" indicators are not illuminated.

If the signal is weak, it may be difficult to tune into the station in stereo. In such a case, Press the **MODE** button on the front panel. Press the **MODE** button or **TUNER** button, and press the **T.MODE** button.

"**AUTO**" indicator is not illuminated, if FM stereo broadcasts are received in monaural and the "**ST**" indicator is not illuminated.

To return to auto stereo mode, Press the **MODE** button or Press **T.MODE** button on the remote again. **AUTO** indicator is illuminated on the display.

## PRESET MEMORY

With this unit you can preset up to 60 FM/AM stations in any order.  
For each station, you can memorize the frequency and reception mode if desired.

### AUTO PRESET MEMORY

This function automatically scans the FM and AM band and enters all stations with proper signal strength into the memory.

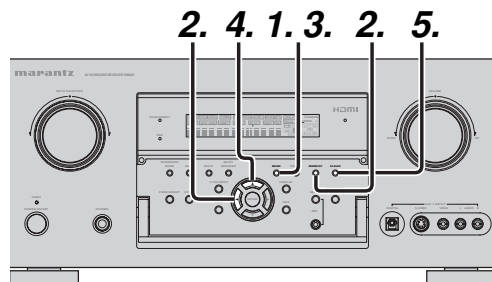

- To select FM, press the **BAND** button on the front panel.
- While pressing the **MEMORY** button, press the **◀** cursor button.  
"AUTO PRESET" will appear on the display, and scanning starts from the lowest frequency.
- Each time the tuner finds a station, scanning will pause and the station will be played for five seconds.  
During this time, the following operations are possible:  
The band can be changed by the **BAND** button.
- If no button is pressed during this period, the current station is memorized in location Preset 02.
- If you wish to skip the current station, press the **▲** cursor button during this period, this station is skipped and auto presetting continues.
- Operation stops automatically when all 50 preset memory positions are filled or when auto scanning attains the highest end of all bands. If you desire to stop the auto preset memory at anytime, press the **CLEAR** button.

## MANUAL PRESET MEMORY

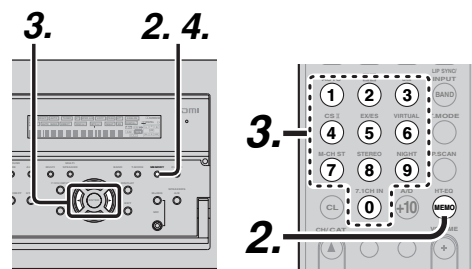

(Using the SR6001)

- Tune into the radio station you desire (Refer to the "MANUAL TUNING" or "AUTO TUNING" section).
- Press the **MEMORY** button on the front panel. "—" (preset number) starts blinking on the display.
- Select the preset number by pressing the **◀** or **▶** cursor buttons, while this is still blinking (approx. 5 seconds)
- Press the **MEMORY** button again to enter. The display stops blinking.  
The station is now stored in the specified preset memory location.

(Using the remote control unit)

- Tune into the radio station you desire (Refer to the "MANUAL TUNING" or "AUTO TUNING" section).
- Press the **MEMO** button on the remote. "—" (preset number) starts blinking on the display.
- Enter the desired preset number by pressing the **numeric** buttons.

### Note:

- When entering a single digit number (2 for example), either input "02" or just input "2" and wait for a few seconds.

## RECALLING A PRESET STATION

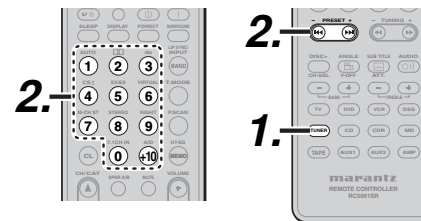

(Using the SR6001)

- Select the desired preset station by pressing the **◀** or **▶** cursor buttons on the front panel.

(Using the remote control unit)

- Press the **TUNER** button twice within two seconds on the remote.
- Press the **PRESET +** or **-** button to tune in the desired preset station.  
Or enter the preset station number with the **numeric** buttons.

## PRESET SCAN

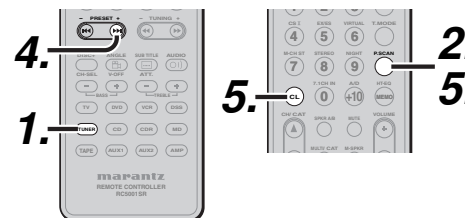

(Using the remote control unit)

- Press the **TUNER** button twice within two seconds on the remote.
- Press the **P.SCAN** on the remote.  
"PRESET SCAN" appears on the front display and then the preset station with the lowest preset number is recalled first.
- Preset stations are recalled in sequence (No.1 → No.2 → etc.) for 5 seconds each.  
No stored preset number will be skipped.
- You can fast forward the preset stations, press the **PRESET +** continuously.
- When the desired preset station is received, cancel the preset scan operation by pressing the **CL** button or **P.SCAN** on the remote.

## PRESET CHANNEL LIST DISPLAY

A complete list of the broadcast channels stored in this unit can be displayed.



- Press the **TUNER** button on the remote control twice within two seconds to switch to the TUNER function.
- Press **INFO** on the remote control.
- The list of preset channels will be displayed on the screen of the TV monitor connected to this unit.

PRESET LIST			
NO. 1	FM	87.10	MHz
NO. 2	FM	93.10	MHz
NO. 3	FM	94.70	MHz
NO. 10	FM	105.70	MHz

- Up to 10 channels can be displayed at a time.  
If there are more than 10 channels, press **INFO** on the remote control once more to display the next page.

The list display will disappear automatically in 5 seconds.



**CLEARING STORED PRESET STATIONS**

You can remove preset stations from the memory using the following procedure.

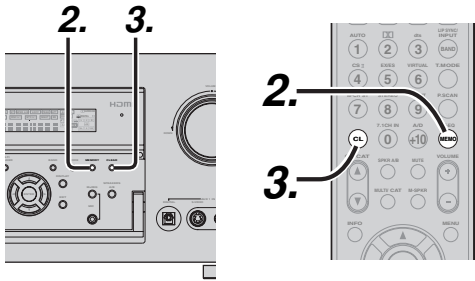

1. Recall the preset number to be cleared with the method described in "Recalling" a preset station.
2. Press the **MEMORY** button on the front panel or press the **MEMO** button on the remote.
3. The stored preset number blinks in the display for 5 seconds. While blinking, press the **CLEAR** button on the front panel or press the **CL** button on the remote.
4. "xx CLEAR" appears on the display to indicate that the specified preset number has been cleared.

**Note:**

- To clear all stored preset stations, press and hold the **CLEAR** and the **ENTER** buttons for two seconds.

**SORTING PRESET STATIONS**

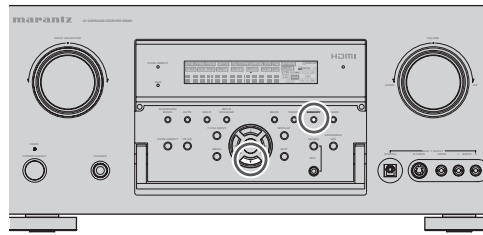

If you have stations memorized, and there is a gap in the sequential order:

I.e. the stations are stored as follows

- 1) 87.1 MHz
- 2) 93.1 MHz
- 3) 94.7 MHz
- 10) 105.9 MHz

(notice there is no stations programmed for pre sets for 4-9), you can have pre set 10 become pre set 5:

To sort the numbers, press and hold the **MEMORY** and the **▼** cursor buttons.

"PRESET SORT" will appear on the display and sorting will be done.

**NAME INPUT OF THE PRESET STATION**

This function allows the name of each preset channel to be entered using alphanumeric characters.

Before name inputting, you need to store preset stations with the preset memory operation.

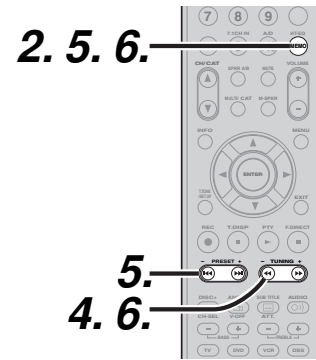
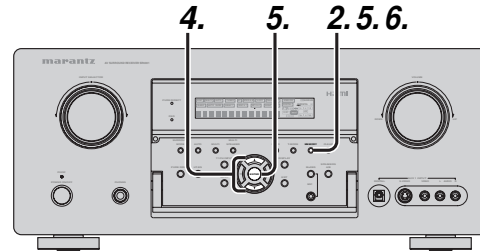

1. Recall the preset number to be inputted name with the method described in "Recalling" a preset station.
2. Press the **MEMORY** button on the front panel or press the **MEMO** button on the remote for more than 3 seconds.
3. The left most column of the station name indicator flashes, indicating the character entry ready status.
4. When you press the **▲** or **▼** cursor buttons on the front panel or the **TUNING +** or **-** buttons on the remote control unit, alphabetic and numeric characters will be displayed in the following order:

A → B → C ... Z → 1 → 2 → 3 ..... 0 → - → +  
 → / → (Blank) → A  
 UP →  
 → DOWN

5. After selecting the first character to be entered, press the **MEMORY** or **ENTER** button, or press the **MEMO** button on the remote.

The entry in this column is fixed and the next column starts to flash. Fill the next column the same way.

To move back and forth between the characters, press the **◀▶** cursor buttons or press **PRESET +** or **-** button on the remote.

**Note:**

- Unused columns should be filled by entering blanks.

6. To save the name, press the **MEMORY** or **ENTER** button on the front panel, or press the **MEMO** button on the remote for more than 2 seconds.

Instead of using the **▲** and **▼** cursor buttons or the **TUNING +** or **-** buttons of the remote controller unit to select characters, characters can be input from the numeric keys of the remote control unit. See the below table for a correspondence between characters and numeric keys.

Ten keypad	Press, press again, press again, etc.
1	A → B → C → 1 → A
2	D → E → F → 2 → D
3	G → H → I → 3 → G
4	J → K → L → 4 → J
5	M → N → O → 5 → M
6	P → Q → R → 6 → P
7	S → T → U → 7 → S
8	V → W → X → 8 → V
9	Y → Z → space → 9 → Y
0	- → + → / → 0

## RDS OPERATION

Now in use in many countries, RDS (Radio Data System) is a description of the station's programming hidden space in the FM signal.

Your new receiver is equipped with RDS to assist in the selection of FM stations using station and network names, rather than broadcast frequencies. Additional RDS functions include the ability to search for programme types.

### RADIO TEXT

Some RDS stations broadcast RADIO TEXT, which is additional information on the station and programme being broadcast.

RADIO TEXT information appears as 'running' text in the display. RADIO TEXT is transmitted character by the radio station. As a result of that it may take some time until the entire text has been completely received.

### RDS DISPLAY

When a receiver is tuned to an FM station that is transmitting RDS data, the Front Panel Information Display will automatically show the station name or RDS TEXT in place of the typical display of the station's broadcast frequency.

To change the display, press the **T.DISP** button on the remote.



PS (Program Service Name) → RT (RADIO TEXT) → Frequency

## PROGRAMME TYPE (PTY) DISPLAY

The RDS system categorizes programmes according to their genre into different programme type (PTY) groups. To display the programme type information of the current station, press the **PTY** button on the remote while in the TUNER mode.



## PTY AUTO SEARCH

Your receiver is equipped to automatically search for stations transmitting any of 29 different programme types. To search for a PTY, follow these procedures:

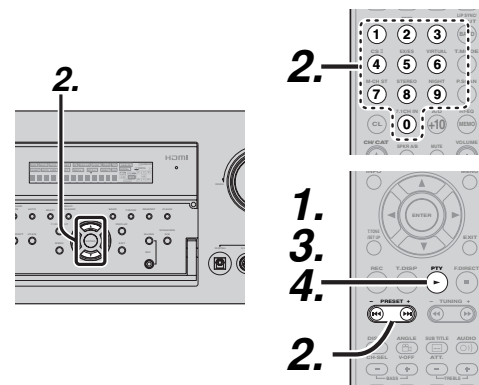

1. Press the **PTY** button in the TUNER MODE on the remote controller. The current station's PTY will be displayed, or the currently selected PTY group will be displayed in blinking if no station or RDS data is present.
2. To change to a new PTY type, press the **TUNING ▲** or **▼** button on the front panel or **numeric** or **PRESET +** or **-** buttons on the remote until the desired PTY is shown in the display.
3. Once the desired PTY group or type has been selected, press the **PTY** button while the display blink (approx. 5 seconds). The PTY Auto search will start, and the tuner will pause at each station broadcasting RDS PTY information corresponding to the selected choice.
4. To advance to the next RDS station with the desired PTY, press the **PTY** button again within 5 seconds.

NUMBER	DISPLAY	PROGRAMME TYPE
1	POP	Pop Music
2	ROCK	Rock Music
3	MOR	M. O. R. Music
4	LIGHT	Light classical
5	CLASSIC	Serious classical
6	NEWS	News
7	AFFAIR	Current Affairs
8	INFO	Information
9	SPORT	Sport
10	EDUCATE	Education
11	DRAMA	Drama
12	CULTURE	Culture
13	SCIENCE	Science
14	OTHERS	Varied
15	OTHER	Other Music
16	WEATHER	Weather
17	FINANCE	Finance
18	CHILDREN	Children's programmes
19	SOCIAL	Social Affairs
20	RELIGION	Religion
21	PHONE IN	Phone In
22	TRAVEL	Travel
23	HOBBIES	Hobbies
24	JAZZ	Jazz Music
25	COUNTRY	Country Music
26	NATION	National Music
27	OLDIES	Oldies Music
28	FOLK	Folk Music
29	DOCUMENT	Documentary

# MULTI ROOM SYSTEM

The Multiroom System mode allows the same source or different sources to be heard in two rooms other than where this receiver is installed.

When using the multiroom system, the audio is output from the MULTI AUDIO output terminals and input to the MULTI ROOM amps.

If a surround channel back speaker or speaker C (see page 23) are not used in the room where this receiver is installed, the multi speaker system can be used with the amp for the surround back channel.

This receiver supports multiroom system functions such as source selectors, OSD menu systems, sleep timers and remote control.

## MULTI ROOM PLAYBACK USING THE MULTI ROOM OUT TERMINALS

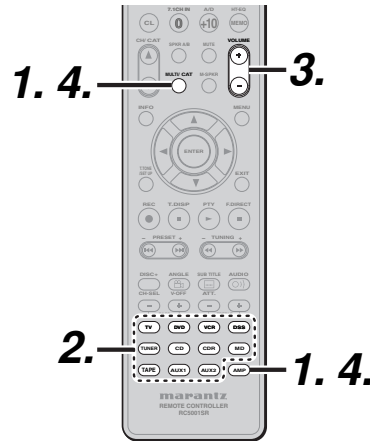
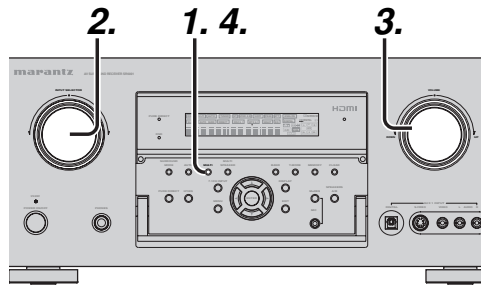

1. Press the **MULTI** button on the unit or remote control (after pressing the AMP button on the remote control). The unit enters MULTI ROOM mode, and the display indicates “**SELECT SOURCE.**” The “MULTI” indicator will flash for about 10 seconds.
2. Select the input source using the INPUT SELECTOR knob or function button on the remote control.  
Then, the display indicates “**MULTI VOLUME**” “**MULTI VOL. xx**” for approx. 5 seconds.
3. During this time, you can set the volume level in the multi room as desired.  
This will only set the volume in the second room.

4. To cancel this function, press the **MULTI** button on the unit or remote control (after pressing the AMP button on the remote control).  
“MULTI” indicator on the front panel will be turned off.

**Note:**

- The sleep timer, monaural output and other features can also be set using the MAIN MENU. (See page 40)

## MULTI ROOM PLAYBACK USING THE MULTI SPEAKER TERMINALS

The SR6001 allows you to connect another set of speakers and place them in a different room or separated area for listening to music.

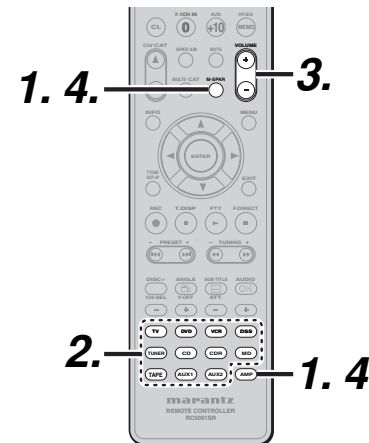
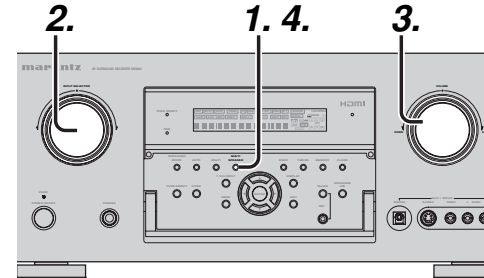

1. Press the **MULTI SPEAKER (M-SPKR)** button. The unit enters multi room speaker mode and the display indicates “**SELECT SOURCE**” and flashes the “MULTI” indicators for approx. 10 seconds.

2. Select the input source using the INPUT SELECTOR knob or function button on the remote control.  
Then, the display indicates “**MSPKR VOLUME**” “**MSPKR VOL.xx**” for approx. 5 seconds.

3. During this time, you can set the volume level in the multi room as desired.

This will only set the volume in the multi room.

4. To cancel this function, press the MULTI button on the unit or remote control (after pressing the AMP button on the remote control).

“MULTI” indicator on the front panel will be turned off.

**Note:**

- The sleep timer, monaural output and other features can also be set using the MAIN MENU. (See page 40.)

**Notes for Multi Room Speaker**

- The MULTI ROOM SPEAKER output terminals can be used when Surround Back Speaker = “NONE” in the SPEAKER SETUP menu. (See SPEAKER SETUP, page 30)
- “The Surr. Back Speakers are in use” is displayed when the MULTI SPEAKER button is pressed when the Surround Back Speaker is not set to “NONE” in the SPEAKER SETUP menu. (See SPEAKER SETUP, page 30)
- The Multispeaker mode cannot be used at the same time as the speaker C. When connecting for multiroom use, set the **SPEAKER C** selector switch on the rear panel to OFF.

## OPERATION OF THE MULTI ROOM OUTPUTS WITH THE REMOTE CONTROL FROM MULTI ROOM

Multi Room output can be operated from a room where the receiver is not installed. This requires a separately sold IR receiver. (For connections, see page 23.)

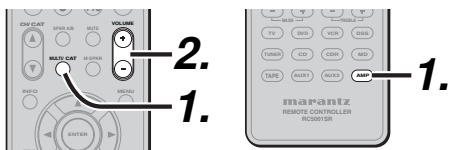

1. Press **MULTI** on the multi room remote control from the MULTI ROOM.

(Press the **AMP** button first to enter the AMP mode then press the **MULTI** button.)

This operations will put the SR6001 into multi room mode and “**MULTI**” will be illuminated on the display.

2. Press the **VOLUME+** or **VOLUME-** button on the multi room remote control to set the desired volume.
3. In multi room mode, the multi room remote control can be used in the multiroom to operate the following functions.

### General:

Controlling volume level, sleep timer, and muting.  
Selecting input audio and video source.

### Tuner:

Selecting band, controlling preset channel up and down, tuning up and down direct frequency call.

### Notes for the Multi Room System

- The MULTI ROOM OUT (MULTI OUT/MULTI SPEAKER) has analog outputs.  
This does not support digital input signals.
- If the Tuner (FM or AM) is active in the main room, you can not control any function of the tuner. In this case, You must listen to the same station as the main room.
- When the component with RC-5 bus is connected to the MULTI RC IN jack (see page 23), Multiroom can be operated using the RC codes for the main room. The remote control units of other Marantz products can also be used to control multiroom.

# TROUBLESHOOTING

In case of trouble, check the following before calling for service:

1. Are the connections made properly ?
2. Are you operating the unit properly following the user's guide ?
3. Are the power amplifiers and speaker working properly ?

If the unit does not operate properly, check items shown in the following table.  
If your trouble cannot be recovered with the remedy actions listed in the following table, malfunction of the internal circuitry is suspected; immediately unplug the power cable and contact your dealer, nearest Marantz authorized dealer or the Marantz Service Center in your country.

SYMPTOM	CAUSE	REMEDY
SR6001 cannot be turned up.	The power plug is not connected.	Connect the power plug to the outlet.
No sound and picture are output even when power is on.	Mute is on.	Cancel mute using the remote control unit.
	The input cable is not connected correctly.	See the connection diagram and connect the cables correctly.
	The master volume control is turned all the way down.	Adjust the master volume.
No speaker output.	The headphones are connected to the headphone jack.	Disconnect the headphones. (Speakers will not output sound when headphones are connected.)
	The function selector position is wrong.	Select correct position.
Incorrect Audio or Video for selected source.	Input cable connected incorrectly.	Connect the cable correctly by referring to the connection diagram.
Incorrect Audio from a channel.	Speaker cable connected incorrectly.	Connect the cable correctly by referring to the connection diagram.
No Audio output from the center channel speaker.	The center speaker cable connection is incomplete.	Connect the cable correctly.
	STEREO has been selected for Surround mode.	When STEREO is selected for Surround mode, no sound will be output from the center speaker. Set another Surround mode.
	Center = NONE has been selected in SETUP mode.	Make the correct setting.
No Audio output from the surround speakers.	The surround speaker cable connection is incomplete.	Connect the cable correctly.
	STEREO has been selected for Surround mode.	When STEREO has been selected for Surround mode, no sound will be output from the surround speaker. Set another Surround mode.
	Surround = NONE has been selected in SETUP mode.	Make the correct setting.
No Audio output from the surround back speakers.	The surround back speaker cable connection is incomplete.	Connect the cable correctly.
	Surround mode is not EX/ES mode.	Set surround mode EX/ES.
	Surround back = NONE has been selected in SPEAKERS SIZE SETUP	Make the correct setting.

SYMPTOM	CAUSE	REMEDY
Can not select EX/ES mode.	Surround center= NONE has been selected in SPEAKERS SIZE SETUP	Make the correct setting.
	Input signal is incompatible.	Use 5.1 channel source.
Can not select Pro Logic IIx mode.	Input signal is incompatible.	Use 2 channel Dolby Digital input signal, PCM input signal or analog input signal.
Can not select Neo:6 mode.	Input signal is incompatible.	Use 2 channel DTS input signal, PCM input signal or analog input signal.
Can not select CSII mode.	Input signal is incompatible.	Use 2 channel Dolby Digital input signal, PCM input signal or analog input signal.
No output to Subwoofer Out.	Subwoofer = NONE has been selected in SETUP mode.	Select Subwoofer = YES.
Noise is produced during DTS-encoded CD or laser disc play.	Analog has been selected for input.	Be sure to perform digital connection, select digital input, then play.
A specific channel does not produce output.	Nothing recorded on source.	Check the encoded channel on the source side.
FM or AM reception fails.	Antenna connection is incomplete.	Correctly connect the indoor FM and AM antennas to FM and AM antenna outlets.
Noise is heard during AM reception.	Reception is affected by other electrical fields.	Try changing location where the AM indoor antenna is set up.
Noise is heard during FM reception.	The radio waves from the broadcasting station are weak.	Install an FM outdoor antenna.
Cannot get programmed station when the PRESET button is pressed.	Preset data has been erased.	Disconnecting power plug for long periods of time will erase preset data. If that happens, input the preset data again.
Control with the remote control unit fails.	Batteries are consumed.	Replace all the batteries with new ones.
	Remote controller's function-key setting is wrong.	Select different position from which equipment will be controlled.
	The distance between this SR6001 and the remote commander is too far.	Move closer to this SR6001.
Auto Setup (SPEAKER SETUP) is not working.	Something is blocking SR6001 and the remote commander.	Remove offending object.
	Headphones are connected.	Disconnect the headphones.

**Note:**

- After "PROTECT" appears on the unit's display, the standby indicator may start flashing. If it does, there is a problem in the unit or the connection. If this problem reoccurs even when power is activated from the remote control unit, call for servicing.

SYMPTOM	CAUSE	REMEDY
The display does not appear over an HDMI connection.	The connected monitor or projector does not support HDCP.	
	The HDMI input of on the TV is not on.	Set HDMI input so that it turns on, as explained in the TV's instruction manual.
	The HDMI output on the source component (DVD, Set Top Box, etc.) is not on.	Set HDMI output so that it turns on, as explained in the source component's instruction manual.
	The HDMI mode is not correctly set on the SR6001.	Set HDMI input on the FUNC INPUT SETUP menu as explained on page 28.
	The HDMI output video resolution of the source component (DVD, Set Top Box, etc.) does not match the TV specifications.	Set the resolution so that it matches, as explained in the instruction manuals of both components.
	The device is connected with a non-standard HDMI cable.	A 5 m or shorter cable is recommended to ensure stable operation and prevent image quality deterioration.
	Power to the SR6001 is off. (When the SR6001 is on standby, HDMI connections cannot be turned on.)	Turn on the power to the SR6001.
	The connection between HDMI components was not authenticated.	Shut off and then turn the power back on to the SR6001, TV and source component.
Time is needed for the display of an HDMI connection to appear.	The connection is being authenticated between the HDMI devices.	There is nothing wrong with the system. Some HDMI devices require time for authentication.
Audio is not played back over an HDMI connection.	The HDMI audio output of the source component (DVD, Set Top Box, etc.) is not on.	Set the HDMI audio output so that it turns on, as explained in the source component's instruction manual.
	The signal format of the source component (DVD, Set Top Box, etc.) is not supported by the SR6001.	Set the HDMI audio output so that it can connect to the SR6001, as explained in the source component's instruction manual.
	The SR6001 is set to the HDMI audio "THROUGH" mode.	In the "THROUGH" mode, sound is not produced from the SR6001. Set it to "ENABLE". (see page 39)
DVD-Audio is not played back over an HDMI connection.	The DVD player does not support CPPM, therefore it cannot output HDMI audio.	<ul style="list-style-type: none"> <li>• Use a DVD-Audio player that supports CPPM.</li> <li>• Turn on PCM downsampling on the DVD player.</li> <li>• Use an analog connection.</li> </ul>



**GENERAL MALFUNCTION**

If the equipment malfunctions, this may be because an electrostatic discharge or AC line interference has corrupted the information in the equipment memory circuits. Therefore:

- disconnect the plug from the AC line supply
- after waiting at least three minutes, reconnect the plug to the AC line supply
- re-attempt to operate the equipment

**Memory backup**

- In case a power outage occurs or the power cord is accidentally unplugged, the SR6001 is equipped with a backup function to prevent memory data such as the preset memory from being erased.

**HOW TO RESET THE UNIT**

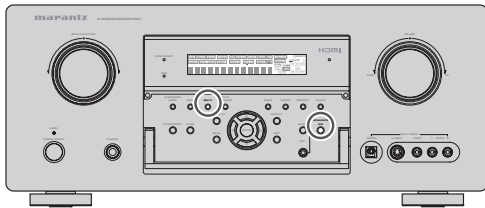

Should the operation or display seem to be abnormal, reset the unit with the following procedure. The SR6001 is turned on, press and hold the **MULTI + SPEAKERS A/B** buttons simultaneously for 3 seconds or more. Remember that the procedure will reset the settings of the function selector, Surround mode, delay time, TUNER PRESET etc., to their initial settings.

**TECHNICAL SPECIFICATIONS**

**FM TUNER SECTION**

Frequency Range ..... 87.5 – 108.0 MHz  
 Usable Sensitivity ..... IHF 1.8 μV/16.4 dBf  
 Signal to Noise Ratio ..... Mono/Stereo 75/70 dB  
 Distortion..... Mono/Stereo 0.2/0.3 %  
 Stereo Separation..... 1 kHz 45 dB  
 Alternate Channel Selectivity ..... ± 300 kHz 60 dB  
 Image Rejection.....98 MHz 70 dB  
 Tuner Output Level ..... 1 kHz, ± 75 kHz Dev 800 mV

**AM TUNER SECTION**

Frequency Range ..... 531 – 1602 kHz  
 Signal to Noise Ratio ..... 50 dB  
 Usable Sensitivity ..... Loop 400μV  
 Distortion.....400Hz, 30 % Mod. 0.5 %  
 Selectivity.....± 20 kHz 70 dB

**AUDIO SECTION**

Power Output (20 Hz – 20 kHz/THD=0.08%)  
 Front L&R ..... 8 ohms 100 W / Ch  
 Center ..... 8 ohms 100 W / Ch  
 Surround L&R ..... 8 ohms 100 W / Ch  
 Surround Back L&R ..... 8 ohms 100 W / Ch  
 Front L&R ..... 6 ohms 120 W / Ch  
 Center ..... 6 ohms 120 W / Ch  
 Surround L&R ..... 6 ohms 120 W / Ch  
 Surround Back L&R ..... 6 ohms 120 W / Ch

Input Sensitivity/Impedance ..... 168 mV / 47 Kohms  
 Signal to Noise Ratio(Analog Input / Pure Direct) .... 105 dB  
 Frequency Response  
 (Analog Input / Pure Direct)  
 ..... 8 Hz – 100 kHz (± 3 dB)  
 (Digital Input / 96 kHz PCM)  
 ..... 8 Hz – 45 kHz (± 3 dB)

**VIDEO**

Television Format..... NTSC/PAL  
 Input Level/Impedance ..... 1 Vp-p/75 ohms  
 Output Level/Impedance..... 1 Vp-p/75 ohms  
 Video Frequency Response ..... 5 Hz to 8 MHz (– 1 dB)  
 Video Frequency (Component) ..... 5 Hz to 80 MHz (– 1 dB)  
 S/N..... 60 dB

**HDMI**

Version.....1.2 [INPUT]  
 .....1.1 [OUTPUT]

**GENERAL**

Power Requirement.....AC 230 V 50 Hz  
 Power Consumption ..... 760 W  
 Weight.....15.0 kg

**ACCESSORIES**

- Remote Control Unit RC5001SR..... 1
- Microphone..... 1
- AAA-size batteries ..... 2
- FM Antenna ..... 1
- AM Loop Antenna ..... 1
- Front AUX Jack Cover ..... 1
- AC cable ..... 1

Specifications subject to change without prior notice.

**DIMENSIONS**

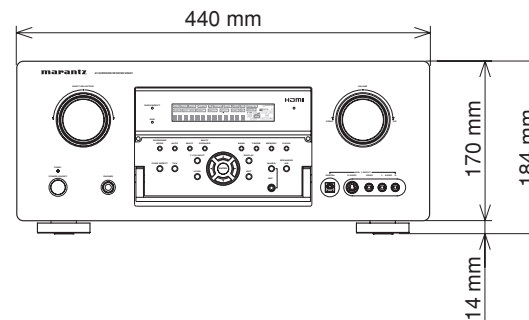
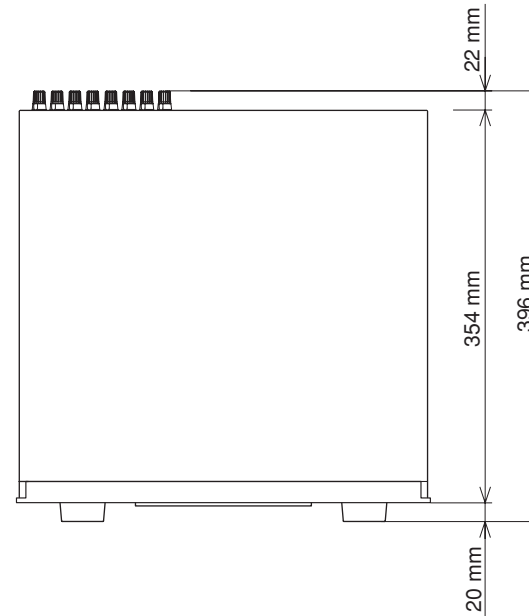

# SETUP CODES

## TV

Acer	1141
Admiral	1002, 1009, 1089
Aiko	1059
Aiwa	1117, 1118
Akai	1001
Amtron	1023
Anam	1113
Anam National	1023, 1069, 1092
AOC	1003, 1024, 1049, 1127
Audiovox	1023
Bell & Howell	1009, 1025
Benq	1104, 1142
Broksonic	1003, 1097, 1098, 1113
Celebrity	1001
Citizen	1003, 1013, 1023 1026, 1059, 1063
Colortyme	1003, 1043
Contec	1113
Contec/Cony	1023, 1045, 1047
Craig	1020, 1022, 1023, 1113
Crown	1023, 1067
Curtis Mathes	1003, 1013, 1025 1026, 1062, 1103, 1110
Daewoo	1003, 1013, 1024, 1035 1036, 1059, 1084, 1101
Daytron	1003, 1013, 1016
Dimensia	1103, 1110
Dumont	1003, 1010, 1153
Electroband	1001
Electrohome	1001, 1003, 1069, 1133
Emerson	1003, 1013, 1015 1020, 1021, 1022, 1023 1025, 1038, 1044, 1045 1048, 1055, 1061, 1094 1096, 1099, 1101, 1113
Envision	1003
Fisher	1025, 1051, 1091, 1160
Fujitsu	1038, 1124, 1125, 1155
Funai	1023, 1038, 1113
Gateway	1150
GE	1003, 1018, 1022, 1046 1054, 1069, 1085, 1103 1110, 1113, 1133, 1136, 1153

Goldstar	1003, 1013, 1024 1030, 1045, 1080 1100, 1112, 1154
Hallmark	1003
Hisense	1116
Hitachi	1003, 1012, 1031, 1032 1037, 1041, 1045, 1047 1065, 1068, 1082, 1088 1094, 1139, 1140, 1145, 1159
Infinity	1067
Janeil	1134
JBL	1067
JC Penney	1003, 1013, 1018 1019, 1024, 1026 1046, 1047, 1054 1063, 1083, 1085 1100, 1103, 1110 1112, 1133, 1154
Jensen	1003
JVC	1028, 1029, 1045 1047, 1050, 1060, 1065
Kawasho	1001, 1003
Kenwood	1003
Kloss Novabeam	1023, 1056, 1057, 1134
KTV	1013, 1023, 1033 1034, 1073, 1099, 1113
LG	1024, 1030
M.Wards	1002, 1009, 1038
Magnavox	1003, 1052, 1053 1056, 1057, 1063 1067, 1081, 1106
Marantz	1003, 1031, 1067, 1122
Mitsubishi	1003, 1024, 1051 1115, 1122, 1133
Motorola	1014, 1069
NEC	1003, 1012, 1024, 1043, 1069
NET-TV	1137, 1150
Orion	1020, 1096
Panasonic	1017, 1067, 1069, 1095, 1111
Philips	1003, 1011, 1045, 1052 1054, 1056, 1057, 1058 1063, 1067, 1069, 1106
Pioneer	1003, 1018, 1037 1070, 1071, 1094 1145, 1147, 1149
Plasmsync	1135
Portland	1003, 1013, 1024, 1059
Price Club	1026
Prism	1018

Proscan	1004, 1005, 1006, 1007 1008, 1085, 1103, 1110
Proton	1003, 1045
Quasar	1010, 1069, 1073, 1111, 1153
Radio Shack	1003, 1013, 1015 1023, 1024, 1025, 1045 1100, 1103, 1110, 1113
RCA	1003, 1004, 1005 1006, 1007, 1008 1014, 1024, 1049, 1069 1075, 1079, 1085, 1087 1088, 1093, 1094, 1101 1103, 1110, 1113, 1153
Realistic	1013, 1015, 1023, 1025 1045, 1100, 1103, 1110
Runco	1010, 1153
Sampo	1150
Samsung	1003, 1013, 1024, 1026 1040, 1045, 1062, 1078 1083, 1090, 1100, 1105, 1114 1120, 1121, 1146, 1148, 1157
Sansui	1119
Sanyo	1003, 1025, 1051, 1072 1077, 1091, 1156, 1157, 1158
Sharp	1003, 1013, 1014 1015, 1045, 1055, 1064 1066, 1076, 1089, 1123
Signature	1009
Sony	1001, 1102, 1108
Soundesign	1003, 1023, 1038, 1063, 1113
Starlite	1023
Supre-Macy	1134
Sylvania	1003, 1039, 1042 1052, 1053, 1056, 1057 1063, 1067, 1089, 1151
Symphonic	1023, 1039, 1044
Tandy	1014
Tatung	1069
Technics	1018
Techwood	1003, 1018
Teknika	1003, 1009, 1013, 1023 1024, 1026, 1038, 1045 1047, 1059, 1063, 1111, 1113
Telecaption	1074
Toshiba	1003, 1019, 1025 1026, 1042, 1074, 1098 1107, 1111, 1135, 1136
Totevision	1013
Universal	1046, 1054

Video Concepts	1113
Viewsonic	1006, 1022, 1109 1128, 1129, 1130, 1131 1138, 1143, 1145, 1150
Wards	1003, 1009, 1015 1024, 1038, 1044, 1046 1052, 1054, 1056, 1057 1067, 1086, 1103, 1110
White Westinghouse	1001, 1101
Yamaha	1003, 1024
Zenith	1003, 1009, 1010 1132, 1144, 1153

## VCR

Admiral	3026, 3060
Adventura	3035
Aiko	3038
Aiwa	3035, 3039
Akai	3003, 3053 3054, 3072, 3073
American High	3009
Asha	3021
Audio Dynamics	3034, 3040, 3083
Audiovox	3052
Beaumark	3017, 3021
Bell & Howell	3029
Broksonic	3029, 3075
Calix	3052
Candle	3012, 3021, 3034 3038, 3050, 3052, 3056
Canon	3008, 3009
Capehart	3050
Carver	3045, 3062
CCE	3038, 3067
Challenger	3078
Citizen	3012, 3021, 3038, 3052, 3056
Colortyme	3034, 3079
Colt	3067
Craig	3021, 3032, 3052, 3067
Criterion	3067
Curtis Mathes	3008, 3009 3021, 3034, 3063
Cybernex	3021
Daewoo	3035, 3038, 3050
Daytron	3038, 3050
DBX	3034, 3040, 3083
Denon	3005

Dimensia .....	3004, 3063, 3085
Dixon .....	3077, 3081
Dynatech .....	3035
Electrohome .....	3052
Electroponic .....	3052
Emerson .....	3009, 3015, 3016, 3017 3018, 3019, 3022, 3035 3047, 3052, 3054, 3073
Fisher .....	3029, 3032
Fuji .....	3003, 3009
Funai .....	3035, 3056
Garrard .....	3035
GE .....	3004, 3008, 3009 3021, 3028, 3058 3063, 3074, 3085
Go Video .....	3021, 3036, 3037 3052, 3067, 3068, 3069
Goldstar .....	3021, 3031, 3034, 3052
Gradiente .....	3035, 3052
Harley Davidson .....	3035
Harman Kardon .....	3034, 3045
Harwood .....	3067
Headquarter .....	3029
Hitachi .....	3004, 3005, 3055, 3072, 3074
Homeline .....	3052
Instant Replay .....	3009
JBL .....	3002
JC Penney .....	3005, 3008, 3009, 3017 3021, 3029, 3034, 3040 3052, 3062, 3067, 3083
JCL .....	3009
Jensen .....	3005, 3072
JVC .....	3014, 3015, 3034 3040, 3041, 3042 3048, 3049, 3072, 3083
Kenwood .....	3029, 3034, 3048, 3072
KLH .....	3067
Kodak .....	3009, 3052
LG .....	3031, 3052
Lloyds .....	3034, 3035, 3056
Logik .....	3067
LXI .....	3052
Magnasonic .....	3038, 3052, 3067
Magnavox .....	3008, 3009, 3010 3045, 3067, 3071
Magnin .....	3021, 3052
Marantz .....	3009, 3029, 3034 3040, 3045, 3062, 3083
Marta .....	3052
MEI .....	3009
Memorex .....	3005, 3009, 3021 3026, 3029, 3032, 3035 3052, 3060, 3067, 3071
MGA .....	3022, 3073
MGN Technology .....	3021
Midland .....	3056
Minolta .....	3005
Mitsubishi .....	3005, 3022, 3023 3025, 3048, 3052, 3073
Montgomery Ward .....	3026, 3060
Motorola .....	3009, 3026, 3060
MTC .....	3021, 3067
Multitech .....	3021, 3035, 3067
NEC .....	3033, 3034, 3040 3048, 3072, 3083
Nikko .....	3052
Noblex .....	3021
Olympus .....	3009
Optimus .....	3026, 3052, 3060
Optonica .....	3027
Orion .....	3015, 3017, 3047, 3052
Panasonic .....	3006, 3007, 3008, 3009, 3067
Pentax .....	3005, 3034, 3074
Philco .....	3005, 3008, 3009, 3047, 3062
Philips .....	3009, 3010, 3027, 3045, 3062
Pilot .....	3052
Pioneer .....	3005, 3040, 3046 3048, 3061, 3080, 3083
Portland .....	3050
Proscan .....	3004, 3063, 3085
Protec .....	3067
Proton .....	3067
Pulsar .....	3021, 3038, 3056, 3071
Quarter .....	3029, 3084
Quartz .....	3029, 3084
Quasar .....	3008, 3009
Radio Shack .....	3021, 3052, 3009, 3008 3035, 3027, 3060, 3026
Radix .....	3052
Randex .....	3052
RCA .....	3004, 3005, 3009 3021, 3046, 3054, 3057 3061, 3063, 3074, 3085
Realistic .....	3008, 3009, 3012, 3021 3026, 3027, 3029, 3032 3035, 3052, 3060, 3084
Ricoh .....	3002, 3059
Runco .....	3071

Samsung .....	3013, 3020, 3021 3056, 3068, 3069, 3070
Sanky .....	3026, 3060, 3071
Sansui .....	3040, 3048, 3067, 3072, 3083
Sanyo .....	3021, 3029, 3032
Scott .....	3012, 3017, 3022, 3052
Sears .....	3005, 3009, 3029 3032, 3034, 3052, 3084
Sharp .....	3026, 3027, 3060, 3064
Shintom .....	3003, 3005, 3067
Shogun .....	3021
Signature .....	3026, 3060
Signature 2000 .....	3026, 3029, 3084
Singer .....	3002, 3009, 3059, 3067
Sony .....	3001, 3003, 3043, 3065
STS .....	3005, 3009
Sylvania .....	3008, 3009, 3022 3035, 3045, 3062, 3076
Symphonic .....	3034, 3035, 3056
Tandy .....	3029, 3084
Tashiko .....	3052
Tatung .....	3072
Teac .....	3035, 3072
Technics .....	3007, 3009
Teknika .....	3009, 3035, 3052
TMK .....	3021
Toshiba .....	3005, 3011, 3012 3022, 3051, 3073
Totevision .....	3021, 3052
Unitec .....	3056
Unitech .....	3021
Vector Research .....	3012, 3034, 3040, 3083
Victor .....	3040, 3083
Video Concepts .....	3012, 3034 3040, 3073, 3083
Videosonic .....	3021
Wards .....	3005, 3009, 3012 3021, 3026, 3027 3032, 3035, 3045 3052, 3060, 3061, 3067
White Westinghouse .....	3035, 3056
XR-1000 .....	3009, 3035, 3067
Yamaha .....	3029, 3034, 3040 3072, 3083, 3084
Zenith .....	3030, 3052, 3053, 3059, 3071

## DVD

Aiwa .....	2036, 2037
Apex .....	2012, 2017, 2018, 2019, 2021, 2034
BOSE .....	2038, 2039
Denon .....	2047, 2048
Funai .....	2049
GE .....	2009, 2020, 2029, 2033
Harman Kardon .....	2061
Hitachi .....	2008, 2012, 2031
JVC .....	2006, 2010, 2040 2041, 2042, 2043
Kenwood .....	2053, 2054
Koss .....	2058
Magnavox .....	2007, 2011, 2023, 2025
Marantz .....	2025
Mitsubishi .....	2011, 2015
Onkyo .....	2062
Oritron .....	2009, 2030
Panasonic .....	2003, 2015, 2016, 2055
Philips .....	2007, 2011, 2058
Pioneer .....	2002, 2014, 2056
Proscan .....	2009, 2020, 2032
RCA .....	2005, 2009, 2020, 2035, 2057
Sampo .....	2041
Samsung .....	2008, 2012, 2022, 2024, 2027
Sanyo .....	2050, 2052
Sharp .....	2044, 2045
Sherwood .....	2051
Sony .....	2001, 2013, 2059
Toshiba .....	2004, 2008, 2026, 2028
Yamaha .....	2046, 2060
Zenith .....	2010

## DSS

Alphastar .....	4027
BSB .....	4021
Chaparral .....	4039
DIRECTV .....	4001, 4016
DISH Network .....	4030
Drake .....	4026
Echostar .....	4007, 4017, 4018, 4019, 4020
Express Vu .....	4017
Fujitsu .....	4025
GE .....	4002, 4008, 4009
General Instruments .....	4036, 4037
Hitachi .....	4001, 4015

Hughes .....	4001, 4016
Janeil .....	4025
JVC.....	4017
Mitsubishi .....	4001
Panasonic.....	4004, 4010
Philips.....	4031, 4035
Proscan .....	4002, 4008, 4009, 4011
Radio Shack.....	4036, 4037
RCA.....	4002, 4008, 4009, 4029
Realistic.....	4040
Rural Cable .....	4036
Samsung .....	4022, 4027
Sony .....	4003, 4012, 4014
Star Choice .....	4032
Star Trak .....	4024
STS .....	4038
SuperDish .....	4028
Toshiba .....	4001, 4034
Uniden .....	4005, 4006, 4013
Video Pall .....	4025
Zenith .....	4025, 4033

**[www.marantz.com](http://www.marantz.com)**

You can find your nearest authorized distributor or dealer on our website.

**marantz**<sup>®</sup> is a registered trademark.

